

User Guide

For:

Blue Radios® Bluetooth® Intelligent Serial Module ATMP Command Set



Audio/Data Evaluation Board Pictured Above with Class1 BR-C40A Radio.

By:

Blue Radios, Inc.

AT HOME. AT WORK. ON THE ROAD. USING BLUETOOTH WIRELESS TECHNOLOGY MEANS TOTAL FREEDOM FROM THE CONSTRAINTS AND CLUTTER OF WIRES IN YOUR LIFE.

Subject matter contained herein is of highly sensitive nature and is confidential and proprietary to **BlueRadios** Incorporated, and all manufacturing, reproduction, use and sale rights pertaining to such subject matter are expressly reserved. The recipient, by accepting this material, agrees that this material will not be used, copied or reproduced in whole or in part nor its contents revealed in any manner to any person or other company except to meet the express purpose for which it was delivered. This document includes data that shall not be disclosed outside of your organization and shall not be duplicated, used, or disclosed, in whole or in part, for any purpose other than to evaluate this document. **BlueRadios**, Incorporated, proprietary information is subject to change without notice.

REVISION HISTORY	5
IMPORTANT NOTES - PLEASE READ PRIOR TO CONTINUING	6
QUICK START GUIDE FOR EVALUATION KIT	7
1 INTRODUCTION	8
2 MULTI-POINT (MP) ARCHITECTURE	12
2.1 USING MULTI-POINT MODE.....	12
2.1.1 Receiving Data in Multi-Point Mode.....	12
2.1.2 Transmitting Data in Multi-Point Mode	12
2.2 MULTIPPOINT EXAMPLES	12
2.3 REPEATER MODE	12
2.4 MESH MODE	12
2.5 MULTIPPOINT TEST SCENARIOS	12
3 AT COMMANDS	12
3.1 THE ATTENTION (AT) COMMAND PREFIX	12
3.2 FIRMWARE VERSION	12
3.3 RESETTING THE RADIO	12
3.4 SET/GET RADIO INFORMATION	12
3.4.1 Get Status Information.....	12
3.4.2 Boot Mode	12
3.4.3 Security Level.....	12
3.4.4 Maximum Number of <i>Bluetooth</i> Connections.....	12
3.4.5 Set and Read Radio Name	12
3.4.6 Set and Read Service Name for Local and Remote Devices	12
3.4.7 Security PIN Settings.....	12
3.4.8 Class of Device (COD).....	12
3.4.9 Write Memory Locations (S Registers) – Radio Configuration	12
3.4.10 Read Memory Locations (S Registers).....	12
3.5 INQUIRY/CONNECT/DISCONNECT COMMANDS.....	12
3.5.1 Inquiry Commands	12
3.5.2 Connect as Master.....	12
3.5.3 Set Master Default <i>Bluetooth</i> Address.....	12
3.5.4 Connect as Slave.....	12
3.5.5 Disconnect	12
3.6 COMMAND/DATA MODES	12

3.7	UTILITIES	12
3.7.1	Cancel Command.....	12
3.7.2	Pairing.....	12
3.7.3	Sniff and Park (Connected Slave).....	12
3.7.4	RSSI and Link Quality.....	12
3.7.5	Audio (SCO) PCM Interface	12
3.7.6	Max TX Power	12
3.7.7	Link Supervisory Timeout.....	12
3.7.8	Variable Storage	12
3.7.9	Connection PIO Logic	12
3.7.10	Transmitting on a Specific Channel Only.....	12
3.7.11	Making the Radio Discoverable and Undiscoverable.....	12
4	USING FTP AND OPP MODES	12
4.1	FTP CLIENT	12
4.1.1	FTP Connect/Disconnect	12
4.1.2	FTP Directory Navigation	12
4.1.3	FTP Push/Pull.....	12
4.2	FTP SERVER	12
4.2.1	FTP Server Push Example Using Broadcomm Stack	12
4.3	OPP CLIENT COMMANDS.....	12
4.3.1	OPP Connect/Disconnect.....	12
4.3.2	OPP Push/Pull.....	12
4.4	OPP SERVER.....	12
4.4.1	Handling OPP Server Business Card Request s.....	12
4.4.2	OPP Server Send Business Card using Broadcom Stack.....	12
4.4.3	OPP Server Receive Business Card using Broadcom Stack.....	12
4.4.4	OPP Server Send Data using TransSend	12
5	BLUERADIOS FACTORY DEFAULT SETTINGS.....	12
6	BLUERADIOS CLASS1 MODULE POWER CONSUMPTIONS.....	12
7	EXAMPLE CONNECTION SEQUENCES.....	12
7.1	MASTER DISCOVERY/CONNECTION SEQUENCE	12
7.2	SLAVE COMMAND SEQUENCE.....	12
7.3	AUDIO AND DATA CONNECTION (FROM MASTER TO REMOTE SLAVE).....	12
8	EXAMPLE SERVER APPLICATIONS.....	12
8.1	HEADSET POINT-TO-POINT	12
8.2	HEADSET MULTIPOINT.....	12
8.3	AUDIO GATEWAY POINT-TO-POINT	12

8.4	AUDIO GATEWAY MULTIPOINT	12
8.5	DUN POINT-TO-POINT	12
8.6	DUN MULTIPOINT	12
8.7	LAN POINT-TO-POINT	12
8.8	LAN MULTIPOINT.....	12
9	EXAMPLE CLIENT APPLICATIONS.....	12
9.1	AUDIO GATEWAY	12
9.2	DUN.....	12
10	ACRONYMS/ABBREVIATIONS	12
APPENDIX A: AT COMMAND SUMMARY TABLE		12
APPENDIX B: VERBALIZATION RESPONSES		12
APPENDIX C: UUID TABLE		12

Revision History

Rev #	Date	Description	Author
3.4.1.0.0	05/08/2006	Production Release for BCO4 BT v2.0 Modules	R.D.Jones/J.M.Sample
3.4.1.1.0	05/26/2006	1) Fixed known CSR H/W flow control issue with packets coming into the UART faster than 100msec while the AT parser is on.	
3.4.1.2.0	6/16/2006	1) While in idle mode and after completing inquiry we turn off PIO(5). 2) Setting auto SCO connect on one BlueRadios device does not require the other device to have SCO set, both will connect SCO automatically. 3) Disabled security as default when power up ATSW25,2,X,X,X idle mode is used so the PAIR,CONNECT does not return.	
3.5.1.0.0	7/24/2006	1) Standardized formatting for all short responses, removed null character from ATRRSN response. 2) ATUCL will now cancel inquiry and connect commands. 3) Setting master connect timeout now works for values between 1-20. 4) ATSW24 now correctly enables and disables security in master mode, security is now not enabled by default. 5) ATUPAIR, ATUPAIRB, and ATCPAIR now correctly clear pairing. 6) Added commands for boot modes, and security levels. 7) Change the delimiting characters to 0x7e while in multi-point mode. 8) Added flag to ATSW25 for mesh configuration. 9) ATPAIR now returns PAIRED,FAILED if pairing fails.	
3.5.1.1.0	7/31/2006	1) Fixed ATDHSCO so it will hang-up the SCO audio channel.	
3.5.2.1.2.0	10/23/2006	Added the following items: 1) Added FTP and OPP Client Commands 2) Added ATSSW,4 (PIO Logic Inversion) 3) Added ATSWC (Specific Transmission Channel in MP Mode)	
3.5.2.1.3.0	11/17/06	1) Fixed Attribute Request Order for ATRRSN. 2) Added NO ANSWER responses for ATRRSN and ATRRN.	
3.5.2.1.4.0	01/05/07	1) With one connection set, no role reversal will be performed. 2) Added FTP and OPP Server Modes in ATSW25 3) Fixed ATSW24,2,0,0,0 – no verbalization response mode will produce no unsolicited data output from the UART 4) Added ATSDIS and ATUDIS Commands 5) Added LINKLOSS response for a dropped connection 6) Made radio unconnectable after an ATDFTP or ATDOPP 7) Added ATSI20 (Channel UUID Status), ATSI21 (Specific Transmission Channel Status), and ATSI22 (FTP/OPP Connection Status) 8) Added Manual PIN Request Handling (ATSSW,6, ATRSW,6, ATPR)	

IMPORTANT NOTES - PLEASE READ PRIOR TO CONTINUING

- Audio is currently supported on Channel 0 only.
- The Bluetooth radio's reset logic is active LOW for C40 and C46 BC04 BTver2.0 modules.
- Unlike the old firmware the new parser design will not accept line feed <lf> after issuing a valid AT Command only a carriage return <cr> shall be used.
- To provide the best firmware architecture, design, and future profile support there is not 100% code backwards compatibility in regards to certain AT Commands and responses. This release firmware is targeted to CSR BC04 platforms. The firmware was developed and tested on BC02 and BC04 platforms. The ATDI command response string no longer returns radio name. There is a separate command to request a remote device name based on CSR's newest design implementation.
- There is an error on Version F of the Eval Board. The two vias marked PIO6 and PIO7 are not connected to their respective pins on the C40 module, only to the C46. If you need to take measurements from these pins you must measure directly from pins 3 and 4 of the radio. This will be corrected in the next version.
- Overall performance improvements from BC02 to BC04:
 - Data throughput for a single point-to-point connection is equal or better than (250Kbps) in fast data mode. While in regular data mode (AT Command parser running) it is only 35Kbps.
 - Current consumption is 15% less.
 - Inquiry responses are much faster.

Quick Start Guide for Evaluation Kit

First, install the CD ROM that came with the *Bluetooth* USB Communicator. This contains the Toshiba *Bluetooth* stack and GUI for Microsoft Windows platforms (98SE, 2000, ME, XP). If you already have Microsoft XP SP2 installed you can just plug in the USB device and Microsoft will recognize it and use its native *Bluetooth* stack interface software.

During installation of the CD when the software prompts for the USB adapter, press 'Cancel'. After the computer reboots, insert the USB device.

Let the Hardware installation wizard install the drivers.

A window will pop up, select 'Express setup'.

Run: Programs -> *Bluetooth* -> *Bluetooth* Settings

Add new connection.

It will find and use a default name 'BlueRadios' after you have successfully powered up the **BlueRadios** Eval Board below:

Plug in the AC/DC wall transformer FIRST.

Wait a second for the voltage to ramp up.

Then plug the DC receptacle jack into the BlueRadios Eval Board, the red LED will light up.

You will see a flashing green LED labeled PIO5.

If the LED does not flash at ~1Hz, the power did not ramp up fast enough for the module to boot properly. You can simply press SW1 (black button) on the Eval Board to reset.

On the computer, press 'BlueRadios' icon for a connection.

The blue LED PIO2 will light on the **BlueRadios** Eval Board.

Run HyperTerminal with factory default settings (do not echo characters or append any additional line feeds). Connect to COM40 at 9600 (8,N,1) baud rate settings, and using hardware flow control. The Toshiba stack program defaults and uses virtual COM40 to minimize physical local com port conflicts on the computer.

PC to PC RF loop-back test:

You can simply connect the DB9 (RS-232) on the Eval Board directly to the same PC's COM1 port using the RS-232 serial pass through cable supplied in the kit. A null modem is not required. Open another HyperTerminal session and use the same baud rate settings above. When using the PC Toshiba Bluetooth stack you may have disconnect and reconnect the HyperTerminal session the first time the unit under test connects.

Embedded testing:

For the DB9 (RS-232) connector, connect the TX(2), RX(3) and GND(5) to the embedded computer or micro controller. If you are not using hardware flow control, connect RTS(7) to CTS(8) on the DB-9 connector. When connecting the TX and RX from the DB9 connector, you cannot connect/short the CTS and RTS at terminal J4 these are two different circuits.

*Note: Most commercial devices ship from the factor with security enabled. If prompted for a PIN it is the lower case word "default" in **BlueRadios** modules. You can disable security on the PC Bluetooth software so you do not always have to enter this.*

1 Introduction

Scope: This ATMP (Multi-Point) Command Set document along with **BlueRadios**® evaluation board was created to enable developers and integrators an opportunity to evaluate wireless networks using *Bluetooth* technology. The goal is to make the transition to *Bluetooth* wireless networks as seamless and easy as possible for our clients. This document will explain how to establish *Bluetooth* communications between two or more **BlueRadios** for both data and voice applications in a point-to-point network (i.e., cable replacement, slave/master communications only).

“Our technology delivers a dynamic experience that comes out of the wireless delivery mechanism and the freedom to connect others.”

Mark J. Kramer – CEO of **BlueRadios**

This document describes the hardware interface of **BlueRadios** Intelligent Serial Module. The Module is designed to be built into an embedded device and to provide a simple and low cost Bluetooth API interface. The module is designed to integrate with a wide range of applications and platforms with a simple electrical and software interface using AT commands.

Background: The **BlueRadios** evaluation board is designed to accommodate the Companies Class1 or Class2 *Bluetooth* radio modem serial modules with 2.4GHz RF ceramic chip antenna (pictured right). The **BlueRadios** SMT modules are *Bluetooth* ver2.0 compliant and use the BC04 Base band processor from CSR. The evaluation board enables a stable platform environment to test serial RS-232 cable replacement and audio communications over *Bluetooth* RF links before going directly to an embedded printed circuit board design and layout.



AT Commands: This document describes the protocol used to control and configure **BlueRadios** *Bluetooth* Serial Modules. The protocol is similar to the industry standard Hayes AT protocol used in telephone modems due to the fact that both types of devices are connection oriented. Appropriate AT commands have been provided to make the module perform the two core actions of a *Bluetooth* device, which is make/break connections and Inquiry. Additional AT commands are also provided to perform ancillary functions.

The CSR (Cambridge Silicon Radio) BC04 base band processors are used in the **BlueRadios** modules. Memory resources are limited therefore it is NOT proposed that there be full implementation of the AT protocol *similar* to an AT modem. But in fact, the protocol is similar enough so the existing source code written for modems can be used with very little modifications with this serial module. Also because of the same resource limitations the Multi-Point modules support connections up to 4 remote devices.

Just like telephone modems, the serial module powers up into an unconnected state and will respond to inquiry and connection requests. Then, just like controlling a modem, the host or client can issue AT commands which map to various *Bluetooth* activities. The command set is extensive enough to allow a host to make connections which are authenticated and encrypted or not. The **BlueRadios** serial radio modems can be configured, commanded, and controlled through simple ASCII strings through the hardware serial UART or over a remote *Bluetooth* RF connection.

1. All commands have the following format: “command”<cr>. Where “cr” represents carriage return 0x0D
2. Valid commands respond with a “<cr,lf>OK<cr,lf>” or “<cr,lf>ERROR<cr,lf>”. Where “lf” represents linefeed 0x0A. The Only exceptions are ATSW20 and ATURST which do not reply (setting baud rate and CPU reset).
3. All response data after the command response have the following format <cr,lf>data<cr,lf>.

HEX vs. Decimal – When writing or entering integer AT Command string values these are typically in Decimal format, when reading values from memory they are returned in HEX (hexadecimal).

Applications: The **BlueRadios** evaluation board can be used for both embedded and PC product applications. It has a RS-232 DB-9 and J4 (0-3.3Vdc) direct UART interfaces to the module. There are radio modem input/output pins (PIO's) connected to terminal lugs for applications that require external command and control. The design incorporates a 13bit mono audio codec, jack, and MIC volume control for wireless headset applications over SCO channel. The audio circuit has minimum filtering for noise, etc.

Pico-Nets: For applications that require more than point-to-point (2) devices communicating simultaneously – this is called a pico-net. These applications require one of the *Bluetooth* devices to manage all the network connections. Because of hardware restrictions, the BlueRadios module supports up to 4 remote slave/master connections and each channel connection status is output to a dedicated PIO pin.

Note: *AT Command interface protocol is not used for the USB Bluetooth communicator. The stack for this resides on the PC side not embedded in the unit like the serial SMT BlueRadios modules.*

Making a Connection

Serial Interface

UART_TX, UART_RX, UART_RTS and UART_CTS form a conventional asynchronous serial data port. The interface is designed to operate correctly when connected to other UART devices such as the 16550A. The signaling levels are nominal 0V and 3.3V and are inverted with respect to the signaling on an RS232 cable. The interface is programmable. The default condition on power-up is pre-assigned in the external 8Mb Flash. Two-way hardware flow control is implemented by UART_RTS and UART_CTS. UART_RTS is an output and is active low. UART_CTS is an input and is active low. These signals operate according to normal industry convention.

BlueRadios shows up under Service discovery defaulted as Serial Port Profile (SPP) Service “COM0, COM1, COM2, and COM3 on BlueRadios”, where COMX is the arbitrary service name and BlueRadios is the local device name. All of these name settings are configurable by the user.

To connect to **BlueRadios**, browse for services, you should see: “**BlueRadios** “Serial Port” as the Profile. **BlueRadios** uses SPP as default, and will be connected to a Virtual COM port on PCs, Palm Pilot's, PocketPCs, or other clients. Once connected, the *Bluetooth* address for each device is exchanged with the message CONNECT, displayed, and data will flow in both directions in regular data mode as if the serial port were locally attached. AT commands can be sent directly to the radios UART when not Bluetooth connected or by any remote *Bluetooth* RF device connection after typing +++ followed by a carriage return. The +++ is the factory default escape sequence to place the radio in command mode when there is a *Bluetooth* RF connection. The Slave radios UART will respond automatically with DISCONNECT {in point-to-point mode} or DISCONNECT,00 {in multi-point mode} when it is disconnected from Channel 00 for example. This verbalization response can be changed to short/long or none if preferred using ATSW24 power up default settings.

BlueRadios Class1 *Bluetooth* device with a high power transceiver (100meters/330 feet) or (10 meters/33 feet) for Class2 performance, however; actual range may vary due to environment, type of antenna, board layout, enclosure design or type of client device used to connect to **BlueRadios**. We have an AT Command to control and set the maximum RF output power.

Note: *Only one device can make connection to BlueRadios at a time, and there is a limit of 8 simultaneous communicating devices in a Bluetooth pico-net network.*

BlueRadios Evaluation Board Physical Ports (3rd Generation)

BlueRadios Signal Name	RS-232 DB-9 Female	0-3.3Vdc TTL Terminal Lugs and Connector Posts	IO DIR
Board PWR		J9-6 (AC/DC Jack)	Power IN (5.0 -12.0 Vdc)
Board GND	5	J4-1, J5-1, J8-1,	<—>
J1 Pin 1 - +V	NC	NC	Not connected
J1 Pin 2 - TX	2	J4-2 (3.3Vdc)	OUT→ 0 - 3.3Vdc
J1 Pin 3 - RX	3	J4-1 (3.3Vdc)	IN← 0 - 3.3Vdc Max Rated
J1 Pin 4 - DTR	4	NC	Not connected
J1 Pin 5 - GND	5	J4-1, J5-1, J8-1	<—>
J1 Pin 6 - DSR	6	NC	Output to PC
J1 Pin 7 - RTS	7	Yes J4-3 (3.3vdc)	OUT→ *(active low)
J1 Pin 8 - CTS	8	Yes J4-4 (3.3Vdc)	IN← *(active low) Max Rated
J1 Pin 9 - RING	9	or J5-6	Optional External Power →IN (5.0 -12.0Vdc)
PIO#2 J3-4	NC	Yes J3-4	{point-to-point mode} <i>Indicates Bluetooth connection</i> {Multi-Point mode} Channel 00 {Multi-point} OUT→ 3.3Vdc (high state) Sink current is 4mA max.
PIO#3 J3-3	NC	Yes J3-3	User definable. IN← 3.3Vdc >1msec pulse interrupt to wakeup CPU from deep sleep without losing first byte of data on UART. Takes 5msec. for CPU to wakeup.
PIO#4 (Triple Purpose)	NC		1) Reset Default ATMP Settings IN← 3.3Vdc for 1 second during initial power up of module. Allow 5 full seconds for change. If not used tie to ground. UART outputs "RESET COMPLETE" 2) Strobe >5msec. to take radio out of Fast data into Command mode and maintain the Bluetooth RF connection. If not RF connected will place radio in Command mode. 3) Strobe >5msec. will auto connect to paired or last Bluetooth connected device if not already RF connected.
PIO#5 J3-1	NC	Yes J3-1	{point-to-point mode} 1Hz output signal while discoverable in Slave mode, ATDI, or ATDM events {Multi-Point mode} <i>Bluetooth connection on Channel 01</i> OUT→ 3.3Vdc (high state) Sink current is 4mA max.
PIO#6 J4-1	NC		{point-to-point mode} <i>User assignable</i> {Multi-Point mode}

BR-AT_COMMANDS-100 Rev. 3.5.2.1.4.0

			<i>Bluetooth</i> connection on Channel 02 OUT→ 3.3Vdc (high state) Sink current is 4mA max.
PIO#7	NC		{point-to-point mode} <i>User assignable</i> {Multi-Point mode} <i>Bluetooth</i> connection on Channel 03 OUT→ 3.3Vdc (high state) Sink current is 4mA max.
6-Pin SPI			
GND J5-1	NC		Optional Ground
MOSI J5-2	NC		Reserved for BlueRadios
SPICK J5-3	NC		Reserved for BlueRadios
SPICS J5-4	NC		Reserved for BlueRadios
MISO J5-5	NC		Reserved for BlueRadios
PWR J5-6	NC		Optional External Power
J4-1 GND	J1-5	J4-1	Ground
J4-2 RST Terminal Lug (active LOW)	NC	J4-2	Soft boots on RST radio pin IN← GND strobe >5msec. Allow CPU 500 msec. to reboot
J4 pins 3,4,5,6	NC	0-3.3Vdc only not RS-232 levels	RTS,CTS, RXD,TXD connect directly into the radio
Reset Push Button Switch (black) active Low		SW1	Soft boots CPU on RST radio pin IN← GND strobe >5msec. Allow CPU 500 msec. to reboot
GND J8-1	J1-5		Use to stimulate PIOs GND (low)
3.3Vdc J8-2			Use to stimulate PIO's 3.3Vdc (high)
Audio Jack (2.5mm)	NC	J7	Use with audio headset

IMPORTANT NOTES:

Placing 3.3Vdc into the PIO's while they are set as outputs will permanently damage the radio modules. The failure mode is short across GND and VCC. When experimenting with the evaluation board use a 10KΩ series resistor when applying power to the terminal screw PIOs directly on the UART.

- Make sure to connect a common ground when using the external TX, RX inputs on the 0 – 3.3Vdc terminal lug connector J4 of the evaluation board.
- If you strobe PWR or GND to the top of the terminal lug screw heads make sure the screw is tighten down or it may not connect the circuit (open circuit).
- For a 3 wire DB-9 interface (tx, rx, gnd only) connect/short CTS to RTS, (J1-7&8). Factory default is hardware flow control enabled CTS and RTS connected.
- PIO's are 0-3.3Vdc not 5 volt tolerant.
- Disconnect RS-232 cable if using 3.3Vdc TX&RX input on J4 terminal lug connector. The Maxim RS-232 chip senses which data input is used between J1&J4 and it sometimes reacts to noise on the DB-9 connector if it is still connected while using J4.
- Use standard pass through RS-232 serial cable. A null modem adaptor is not required.
- Tie "Factory Reset" high if not in use to prevent inadvertent resetting of parameters during initial module power up for your modules or disable this software feature using ATSSW,0. The remaining pins can float.

You can connect the RS-232 DB-9 evaluation board directly to the PC without an RS-232 pass through cable or null modem.

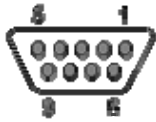

Female DB-9

Power Terminals for Evaluation Board

Inputs on J9 & J10 can be $\geq 5VDC$ and $\leq 12.0VDC$. Worst case power draw for the entire evaluation board is 150ma when the *Bluetooth* radio/modem connection is established and transmitting. Power consumption is much lower depending on parameter settings.

Hardware UART Communications Connections for Modules and Eval Board

Radio module **TX UART** → **RX** of the application Micro Controller Unit (MCU)

Radio module **RX UART** ← **TX** of the application Micro Controller Unit (MCU)

Radio module **RTS UART** → **CTS** of the application Micro Controller Unit (MCU)

Radio module **CTS UART** ← **RTS** of the application Micro Controller Unit (MCU)

PCMIF (Audio)

The module supports 13 bits Linear CODEC interface and the module is configured as master mode of PCM I/F.
1) PCM_OUT, PCM_IN, PCM_CLK, and PCM_SYNC carry one of bi-directional channel of voice data using 13bits PCM at 8ks/s.

2) PCM_SYNC is output and operates at a fixed clock frequency of 8kHz.

3) PCM_CLK is output and operates at a fixed clock frequency of 256kHz.

4) Reference PCM audio device is Motorola MC145483 13 bit linear CODEC or Windbond W681360R (recommended for new designs)

Evaluation Board Block Diagram

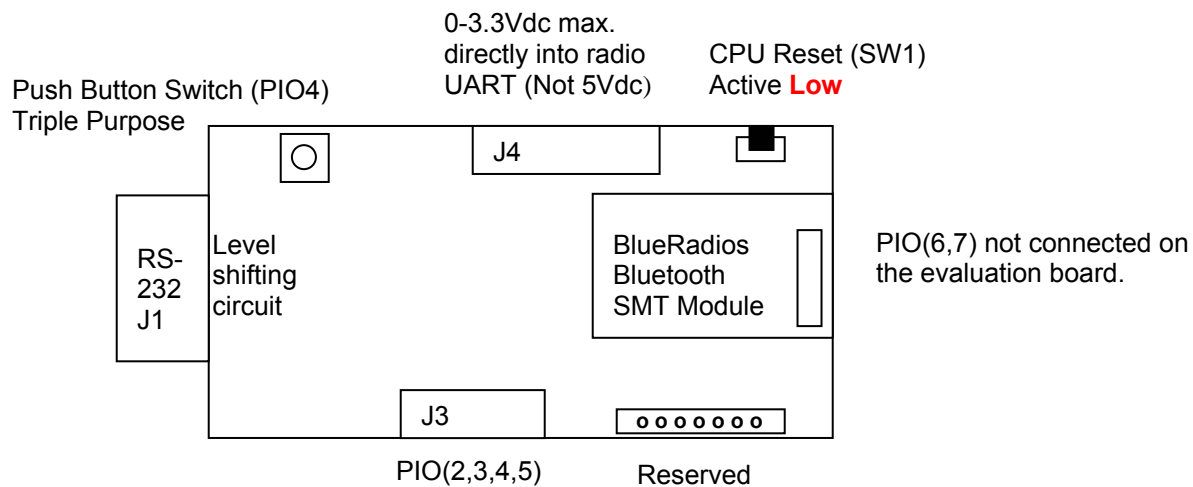

LEDs

The **RED** LED next to power terminals should come on whenever the unit has power supplied. The **Blue** LED on the PIO(2) should go-on whenever the unit is connected to another Bluetooth device. The remaining **Green** LED's are defined for the following PIO table:

Radio Module I/O	Class1, 2, 3 Radio Module BR-C40 BTver2.0 Class2, 3 Radio Module BR-C46 BTver2.0	LED Color on Evaluation Board
PIO(2)	Yes	Blue BT Connection Established Bluetooth connection on Channel 00
PIO(3)	Yes	Input only - >1msec deep sleep wakeup interrupt. Takes CPU 5msec to wakeup.
PIO(4) (Triple Purpose)	Yes – Restores Factory Default Settings when held high for >2 second during initial power up. 2) >5msec pulse after power up will place radio into command mode. 3) >5msec pulse will connect to paired device or last connected device.	Green
PIO(5)	Yes – Pulses 1/sec. for Slave mode indication and if processing Master inquiry requests	Green Bluetooth connection on Channel 01
PIO(6)	Not connected on Eval Board	Bluetooth connection on Channel 02
PIO(7)	Not connected on Eval Board	Bluetooth connection on Channel 03
All PIO's	Max Sink Current is 4mA max.	

Changing Configuration

Parameters, such as the *Bluetooth* Name, Service Name, Class of Device and Serial Port settings can be viewed and configured. This can be done locally through the serial port UART or from a remote *Bluetooth* RF link. To access configuration, the **BlueRadios** must be in command mode and enable to except AT Commands. While in command mode **BlueRadios** will accept ASCII bytes as commands.

Use a normal RS-232 pass through cable from PC passing ASCII characters through the terminal to the **BlueRadios**. The communications settings should match the settings used when **BlueRadios** connects, for example: the default is 9600bps, 8 Data Bits, No Parity, 1 Stop Bit, and hardware flow control enabled. Once you change these parameters, you have the option to store them permanently in non-volatile memory.

Run your favorite terminal emulator, HyperTerminal or other program. Type “AT” on your terminal screen and follow it with a carriage return <cr>. You should see “OK” returned to you. This will verify that your cable and communications settings are correct on the radios hardware UART. Make sure you do not have the scroll lock enabled on the keyboard. When the radio is not connected to another *Bluetooth* device you can type the AT commands directly into the radios UART. If the radio is Bluetooth connected you will need to send +++<cr> on the local UART to take the radio out of data mode and place it in command mode. You can enter any of the AT commands in the up coming sections, followed by <cr>. Commands will return an “OK”, for valid response, and invalid ones will reply ERROR. To go back to regular data mode while RF connected type ATMD to pass or receive data from a remote connected *Bluetooth* device.

Note: If changing communications parameter settings, remember to change your terminal or emulator comm. settings to correspond to the new parameter settings you just have made.

Also, we have seen some strange communications effects using HyperTerminal in conjunction with a PC using various *Bluetooth* stack and virtual com ports. As an example; communications works only in one direction. Requires closing both HyperTerminal programs and starting both HyperTerminal sessions again.

2 Multi-Point (MP) Architecture

2.1 Using Multi-Point Mode

The ATMP supports any combination of Client/Server connections up to a maximum of 4. The modules are shipped and factory defaulted as Slaves supporting point-to-point connections. The PIO functionality is the same as previous releases when in this mode. By using the AT Command ATSSW,3 you can increase the number of Bluetooth connections. However when you set the module to multiple channels we automatically reassign the following PIO's: Channel 00 – PIO(2), Channel 01 – PIO(5), Channel 02 - PIO(7), Channel 03, PIO(8). PIO(5) will no longer toggle at 1Hz.

To maintain backwards compatibility we maintain the same commands for point-to-point configuration. Commands like ATRSSI are the same but while in Multi-Point mode we added the Letter "C" for ATRSSIC,2 to indicate the remote channel number to request this information from.

When the module is setup for more than one connection the connections are all in regular data mode and you can not command the connection(s) in Fast Data Mode because the internal parser needs to interpret where the data is originating from. So in Multi-Point Mode there is no such thing as Fast Data Mode. If you are communicating to the ATMP local hardware UART in command mode and an incoming remote connection comes in, then the ATMP automatically goes into data mode and is no longer in command mode. You will want to monitor the PIO connect channel status lines to make sure what state the ATMP is in.

As you are transmitting or receiving data to any given channel the average inquiry and connection time for each additional connection roughly doubles in time. This is because the CPU is busy processing data and each additional channel and consumes more and more resources with each connection. Therefore we can not spec the data throughput or overall system performance because it depends on a lot of independent and dependant variables in regards to the number of connections, when and how much data is being processed, and if the ATMP is being inquired by other nearby *Bluetooth* devices. A typical design implementation should be one in which data is not transmitted or received simultaneously from all connections to prevent the CPU from crashing.

Note: Multi-point mode will be overridden by FTP or OPP modes. If the radio makes a client FTP or OPP connection or is configured as an FTP or OPP server, the radio will no longer be in Multi-point mode.

2.1.1 Receiving Data in Multi-Point Mode

When receiving data in Multi-Point mode, a typical interleaved UART data stream for 4 *Bluetooth* connections coming in on 4 separate channel identifiers will look similar to this depending on the order they were sent from the remote units to the ATMP:

```
<0x7E>00,data payload1234567890<0x7E>01,data payload12345678901234567890<0x7E>02,data  
payload123456789012345678901234567890<0x7E>03,datapayload123456789012345678901234567890123456  
7890<0x7E>02,data payload123456789012345....
```

The data payload size is not fixed and is variable in length. The channel header `<0x7E>0#`, will be sent whenever data from another channel comes in. The # character represents the channel number of the following data. The header is only sent once if no other channels report in during the period to lower the communications overhead of the protocol. The ATMP Server needs this method to identify the origination of incoming data for a single physical hardware output UART on the ATMP radio, therefore data is interleaved as shown above.

2.1.2 Transmitting Data in Multi-Point Mode

By default data is broadcast to all connected radios when the local radio is in data mode. The radio can be set to transmit to a specific channel using the ATSWC command. (See the Utilities section for more information)

2.2 Multipoint Examples

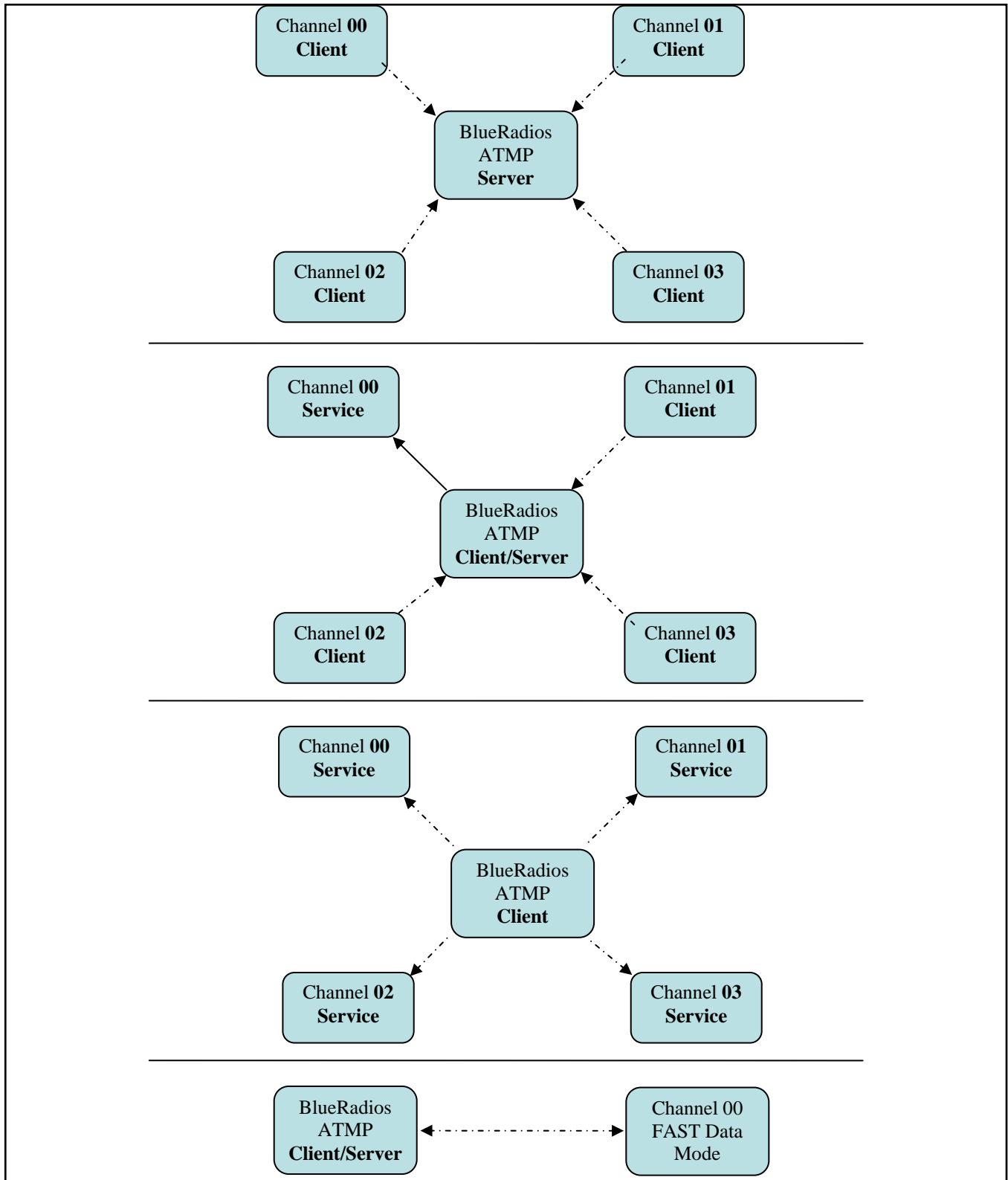

2.3 Repeater Mode

Repeater mode can be set using the ATSW25 and ATSMMA Commands.

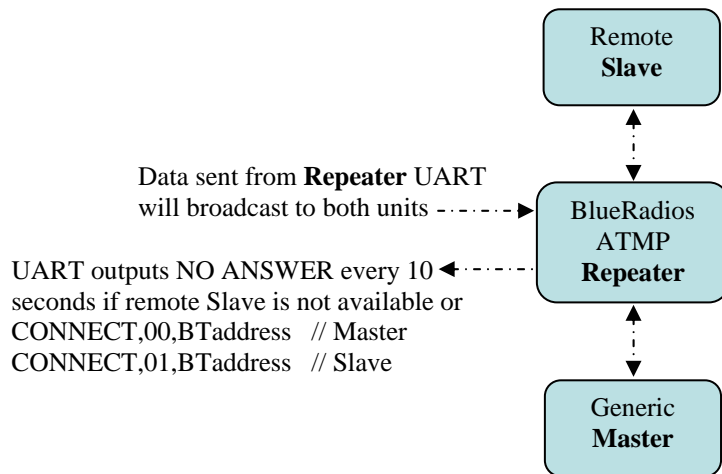

2.4 Mesh Mode

Below is the Mesh Network architecture that can be enabled using the ATSW25 Command. This is for advanced users only.

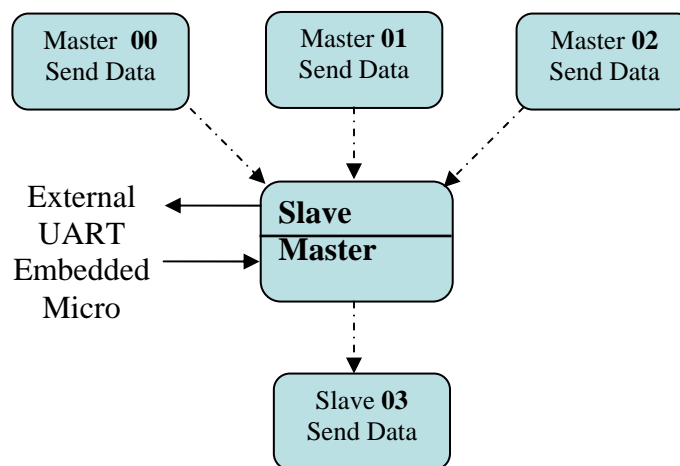

2.5 Multipoint Test Scenarios

The following test examples were all performed by holding down a single key on a PC sending one character every 50-100 msec, which is a worse case to sending more characters less often because the radio has to service interrupts more often. Data was transmitted in one direction only and units under test were all in the same room. Performance will decrease at further distances and if data is full duplex will probably crash with even fewer connections.

Test Scenario 1:

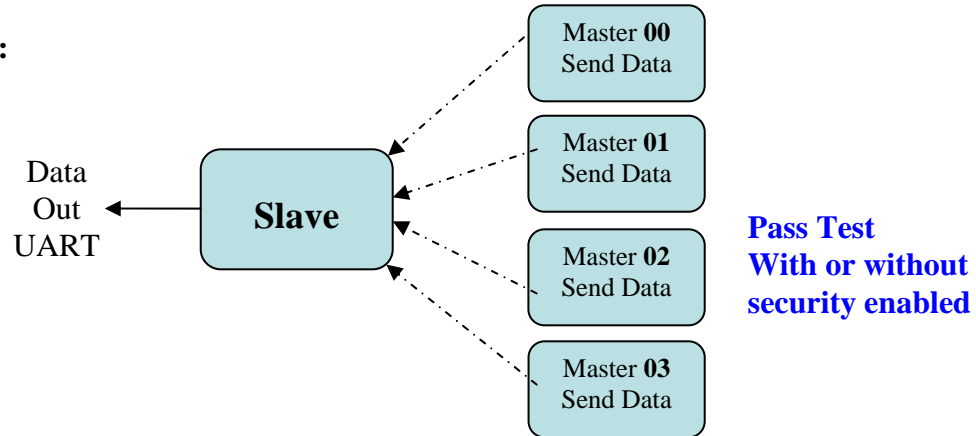

Test Scenario 2:

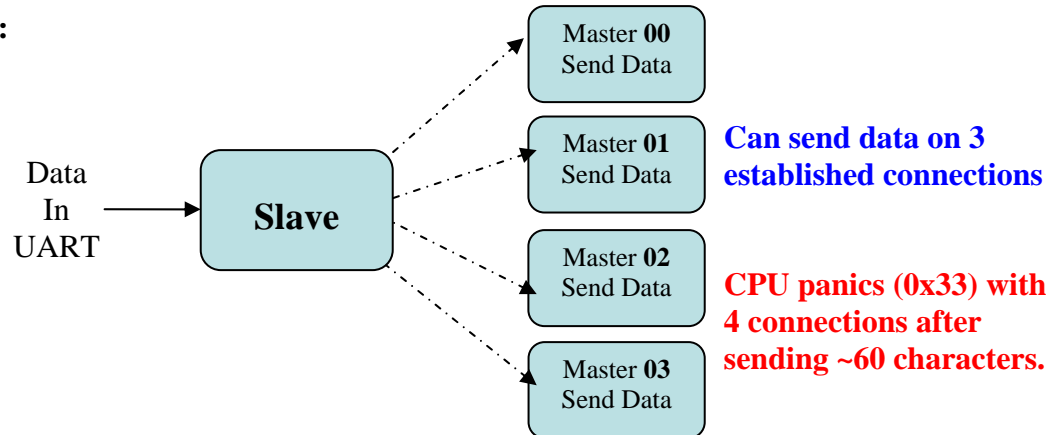

Test Scenario 3:

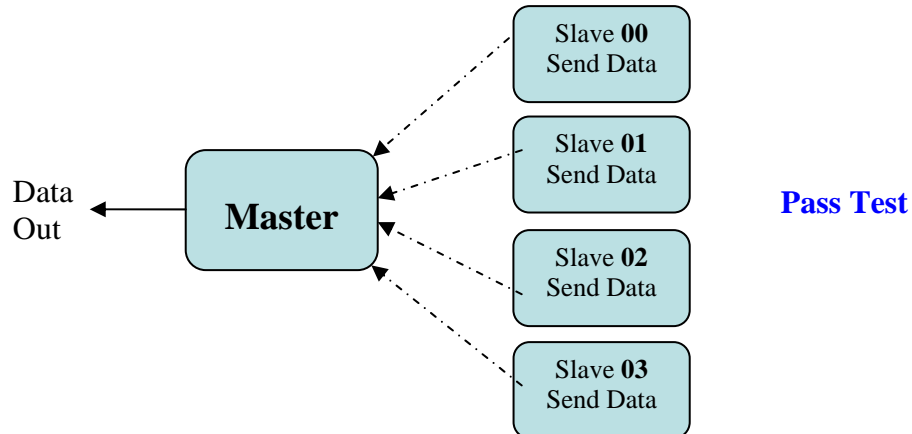

Test Scenario 4:

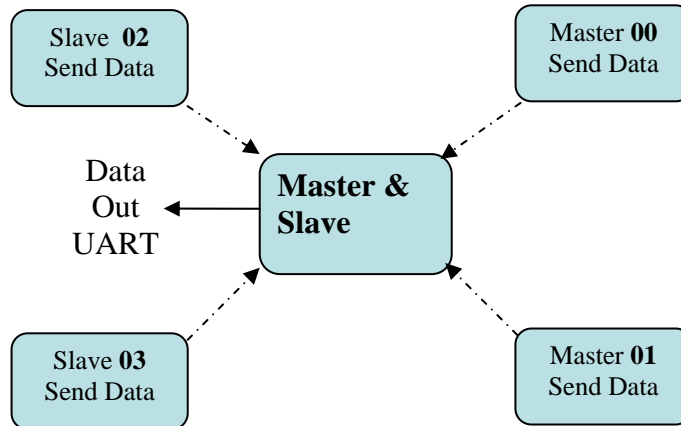

Pass Test

Test Scenario 5:

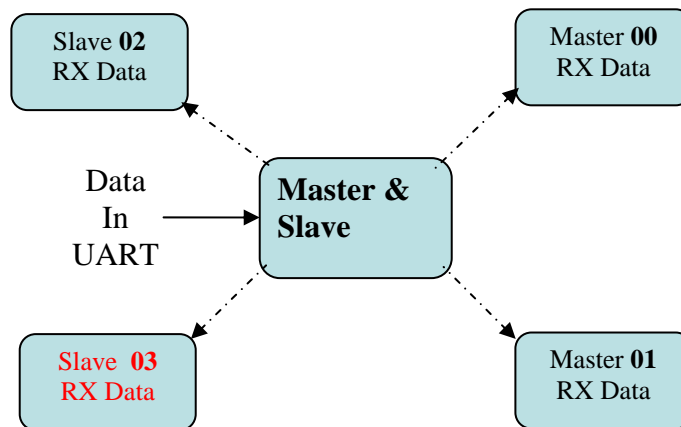

Can send data on 3 established connections

Unit crashes on 4 connections after sending ~60 characters

Test Scenario 6:

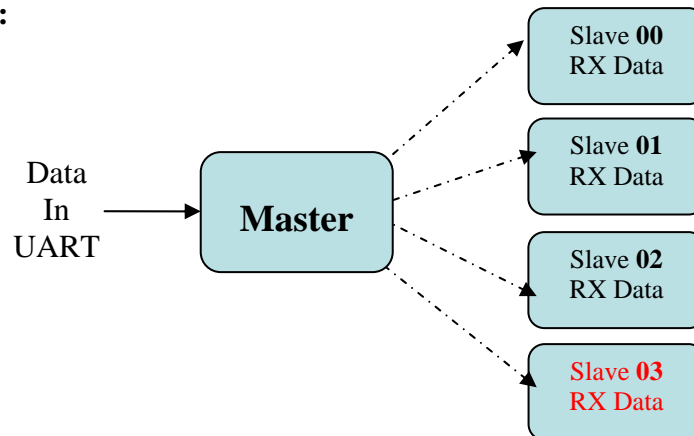

Pass Test for 3 connections

With 4 connections CPU panics (0x33) after ~60 characters

3 AT Commands

IMPORTANT NOTES:

- All commands are typed exactly as shown in the examples.
- `<cr>` = `<0x0d carriage return>`
- `<cr_lf>` = `<0x0d carriage return> <0x0a linefeed>`
- All commands are entered in the following format: "COMMAND"`<cr>`.
- Valid commands respond with a `<cr_lf>OK<cr_lf>` or `<cr_lf>ERROR<cr_lf>`.
- Only exceptions are ATSW20 and ATURST which do not reply.
- All replied data after the command response has the following format `<cr,lf>data<cr,lf>`.
- Allow at least a 100ms delay between subsequent AT commands.
- HEX vs. Decimal – When writing or entering integer AT Command string values enter them in Decimal format. When reading values from memory they will be returned in Hexadecimal.
- If using HyperTerminal the following check box should be disabled: Send line ends with line feeds. If not the commands will not be submitted correctly.

3.1 The Attention (AT) Command Prefix

AT	<p>AT PREFIX</p> <p>Function: The prefix AT must precede every valid command except for "+++". The remainder of the command script contains commands for the radio. The command script must end with a carriage return.</p> <p>EXAMPLE:</p> <p>TYPE : AT<cr></p> <p>REPLY: <cr_lf>OK<cr_lf></p> <p>Note: AT Commands can be upper or lower case. The only exception is the radios Personal Identification alphanumeric Number (PIN) is caps sensitive, and ATOP.</p>
-----------	---

3.2 Firmware Version

VER	<p>GET MODULE FIRMWARE VERSION</p> <p>Function: Gets the radio's firmware version.</p> <p>Format: ATVER,ver1</p> <p>Return Parameters: <Firmware Version></p>
------------	---

EXAMPLE:

```
TYPE : ATVER,ver1<cr>
REPLY: <cr_lf>OK<cr_lf>
       <cr_lf>Ver 3.5.2.1.4.0<cr_lf>
```

Notes:

- "ver1" is case sensitive, be sure to enter it in lower case.
- Make sure the radios's version number matches this document version before proceeding.

3.3 Resetting the Radio

URST	<p>RESET</p> <p>Function: Tells the radio to perform software reset on the CPU.</p> <p>Format: ATURST</p> <p>EXAMPLE:</p> <pre>TYPE : ATURST<cr> REPLY: None</pre> <p>Notes:</p> <ul style="list-style-type: none"> ▪ <i>This unique Command does not reply with "OK" or "ERROR" because of internal UART data processing limitations and response timing.</i> ▪ You can send the reset command through the UART or over the Bluetooth RF connection. ▪ The BlueRadios evaluation board has a convenient manual pushbutton software reset switch on the PCB labeled SW1.
FRST	<p>FACTORY RESET</p> <p>Function: Resets the radio back to factory defaults.</p> <p>Format: ATFRST</p> <p>EXAMPLE:</p> <pre>TYPE : ATFRST<cr> REPLY: <cr_lf>OK<cr_lf> <cr_lf>RESET COMPLETE<cr_lf> OR <cr_lf>ERROR<cr_lf></pre> <p>Notes:</p> <ul style="list-style-type: none"> ▪ You can send the factory reset command through the UART or over the Bluetooth RF connection.

	<ul style="list-style-type: none"> The BlueRadios evaluation board has a convenient manual pushbutton factory reset switch on the PCB labeled PIO(4). It resets the radio back to factory defaults if the button is held down while power is applied to the radio. Allow 2 seconds for the Radio to read and write to FLASH.
SSW,0	<p>SET BYPASS FOR HARDWARE FACTORY CONFIGURATION RESET PIO(4)</p> <p>Function: Use this command in replace of physically connecting PIO(4) to ground to prevent an inadvertent factory configuration reset.</p> <p>Format: ATSSW,0,<Enable/Disable></p> <p>Parameters:</p> <ul style="list-style-type: none"> <i>Enable/Disable:</i> <ul style="list-style-type: none"> 0 = PIO(4) factory reset enabled 1 = PIO(4) factory reset disabled <p>EXAMPLE:</p> <pre>TYPE : ATSSW,0,1<cr> REPLY: <cr_lf>OK<cr_lf> OR <cr_lf>ERROR<cr_lf></pre> <p>Read Using: ATRSW,0</p>
RSW,0	<p>READ BYPASS FOR HARDWARE FACTORY CONFIGURATION RESET PIO(4)</p> <p>Function: Reads the PIO(4) factory reset enable/disable register state.</p> <p>Format: ATRSW,0</p> <p>Return Parameters: <Enable/Disable></p> <p>EXAMPLE:</p> <pre>TYPE : ATRSW,0<cr> REPLY: <cr_lf>OK<cr_lf> <cr_lf>00<cr_lf></pre> <p>Set Using: ATSSW,0</p>

3.4 Set/Get Radio Information

3.4.1 Get Status Information

Status Information can be obtained directly from the *Bluetooth* Radio. This information is important when managing a connection list of devices in a local area and current settings of the radio.

SI	<p>STATUS INFORMATION</p> <p>Function: Gets specified status information from the LOCAL radio.</p>
----	---

Format: ATSI,<Status Request>

Parameters:

- *Status Request:* Integer 0 - 19

- If "Set Using" field is listed, see listed AT command for more info on return parameters

0 GET MODULE TYPE

Return Parameters: <Module Type>

EXAMPLE:

TYPE : ATSI,0<cr>

REPLY: <cr_lf>OK<cr_lf>

<cr_lf>BlueRadios ATMP<cr_lf>

1 GET BT ADDRESS

Return Parameters: <BT Address>

EXAMPLE:

TYPE : ATSI,1<cr>

REPLY: <cr_lf>OK<cr_lf>

<cr_lf>123456789012<cr_lf>

2 GET FRIENDLY NAME

Set Using: ATSN

Return Parameters: <Friendly Name>

EXAMPLE:

TYPE : ATSI,2<cr>

REPLY: <cr_lf>OK<cr_lf>

<cr_lf>BlueRadios<cr_lf>

3 GET CURRENT CONNECTION STATUS (CH00-CH03)

Return Parameters: <Connection Status>

Connection Status:

Single Connection Format: (Mode, Ch00 State)

MP Format: (Mode,Ch00 State,Ch01 State,Ch02 State,Ch03 State)

Repeater Format: (Mode,Slave-Ch00 State,Master-Ch01 State)

Modes: 0 = Slave, 1 = Auto-Master, 2 = Idle, 3 = Slave Undiscoverable, 5 = Repeater, 6 = Mesh

States: 0 = Disconnected, 1 = Connected

EXAMPLE:

TYPE : ATSI,3<cr>

REPLY: <cr_lf>OK<cr_lf>

<cr_lf>1,0,0,0,0<cr_lf>

Note: This command does not report the status of any FTP or OPP connections, use ATSI,22 to obtain FTP/OPP status.

4 GET SERVICE NAME

Set Using: ATSSN
Return Parameters: <Service Name>
EXAMPLE:
TYPE : ATSI,4<cr>
REPLY: <cr_lf>OK<cr_lf>
 <cr_lf>COM0<cr_lf>

5 GET CLASS OF DEVICE (COD)

Set Using: ATSC
Return Parameters: <COD>
EXAMPLE:
TYPE : ATSI,5<cr>
REPLY: <cr_lf>OK<cr_lf>
 <cr_lf>00000000<cr_lf>

6 GET RESPONSE, SECURITY, AUTO SCO, FILTER SETTINGS

Set Using: ATSW24
Return Parameters: <Response Type>,<Security>,<Auto SCO>,<Minor Filter>
EXAMPLE:
TYPE : ATSI,6<cr>
REPLY: <cr_lf>OK<cr_lf>
 <cr_lf>0,0,0,0<cr_lf>

7 GET CONNECTION, COMM, UNCONNECTED UART, DEFAULT SERVICE MODES

Set Using: ATSW25
Return Parameters: <Power-Up Connection Mode>,<Comm Mode>,
 <Unconnected UART Mode>,<Default Service>
EXAMPLE:
TYPE : ATSI,7<cr>
REPLY: <cr_lf>OK<cr_lf>
 <cr_lf>0,1,0,0<cr_lf>

8 GET UART SETTINGS

Set Using: ATSW20
Return Parameters: <Baudrate>,<Parity>,<Stop Bits> (HEX)
EXAMPLE:
TYPE : ATSI,8<cr>
REPLY: <cr_lf>OK<cr_lf>
 <cr_lf>0027,0000,0000<cr_lf>

9 GET MASTER AUTO-CONNECT ADDRESS

Set Using: AT SMA
Return Parameters: <BT Address>,<UUID>
EXAMPLE:
TYPE : ATSI,9<cr>
REPLY: <cr_lf>OK<cr_lf>
 <cr_lf>Not Set!<cr_lf>
OR
 <cr_lf>OK<cr_lf>
 <cr_lf>123456789012,1101<cr_lf>

10 GET SLAVE SCAN INTERVALS AND WINDOWS

Set Using: ATSW21
Return Parameters: <psInterval>,<psWindow>,<isInterval>,<isWindow>
(HEX)

EXAMPLE:

TYPE : ATSI,10<cr>
REPLY: <cr_lf>OK<cr_lf>
<cr_lf>0400,0200,0400,0200<cr_lf>

11 GET PIO(5) PULSE RATE

Set Using: ATSW27
Return Parameters: <Pulse Period [ms]> (HEX)

EXAMPLE:

TYPE : ATSI,11<cr>
REPLY: <cr_lf>OK<cr_lf>
<cr_lf>03E8<cr_lf>

12 GET ESCAPE CHARACTER

Set Using: ATSESC
Return Parameters: <ASCII Char> (HEX)

EXAMPLE:

TYPE : ATSI,12<cr>
REPLY: <cr_lf>OK<cr_lf>
<cr_lf>2B<cr_lf>

13 GET INQUIRY AND MASTER CONNECT TIMEOUT SETTINGS

Set Using: ATSW28
Return Parameters: <Inquiry Timeout>,<Master Connect Request
Timeout> (HEX)

EXAMPLE:

TYPE : ATSI,13<cr>
REPLY: <cr_lf>OK<cr_lf>
<cr_lf>0010,0028<cr_lf>

14 GET MAX TX POWER LEVEL

Set Using: ATSPF
Return Parameters: +/-<Power Level> (HEX)

EXAMPLE:

TYPE : ATSI,14<cr>
REPLY: <cr_lf>OK<cr_lf>
<cr_lf>default<cr_lf>

OR

REPLY: <cr_lf>OK<cr_lf>
<cr_lf>+0A<cr_lf>

15 GET PIN LOCK MODE

Set Using: ATSW29
Return Parameters: <Lock Mode> (HEX)

EXAMPLE:

TYPE : ATSI,15<cr>
REPLY: <cr_lf>OK<cr_lf>
<cr_lf>00<cr_lf>

16 GET DEEP SLEEP MODE

Set Using: ATSW30

Return Parameters: <Deep Sleep Mode> (HEX)

EXAMPLE:

```
TYPE : ATSI,16<cr>
REPLY: <cr_lf>OK<cr_lf>
      <cr_lf>00<cr_lf>
```

17 GET SNIFF SETTINGS

Set Using: ATSSNIFF

Return Parameters: <Max Interval>, <MinInterval>, <Attempt>, <Timeout>
(HEX)

EXAMPLE:

```
TYPE : ATSI,17<cr>
REPLY: <cr_lf>OK<cr_lf>
      <cr_lf>Not Set!<cr_lf>
OR
      <cr_lf>OK<cr_lf>
      <cr_lf>0000,0000,0000,0000<cr_lf>
```

18 GET LINK SUPERVISORY TIMEOUT

Set Using: ATLSTO

Return Parameters: <Time> (HEX)

EXAMPLE:

```
TYPE : ATSI,18<cr>
REPLY: <cr_lf>OK<cr_lf>
      <cr_lf>04<cr_lf>
```

19 GET LIST OF PAIRED OR SECURED ADDRESSES

Set Using: ATPAIR

Return Parameters: Index, <BT Address> (HEX)

EXAMPLE:

```
TYPE : ATSI,19<cr>
REPLY: <cr_lf>OK<cr_lf>
      00,<cr_lf>
      01,<cr_lf>
      02,<cr_lf>
      03,<cr_lf>
```

Note: 00 - 03 Are for indexing the stored addresses only, they do not indicate that the address is associated with any specific channel.

20 GET CHANNEL UUIDS

Set Using: ATSSNC

Return Parameters: <Ch00 UUID>, <Ch01 UUID>, <Ch02 UUID>, <Ch03 UUID>
(UUIDs for Ch01-03 will only be returned if enabled using ATSSW3)

EXAMPLE:

```
TYPE : ATSI,20<cr>
REPLY: <cr_lf>OK<cr_lf>
      <cr_lf>1101<cr_lf> //Point to point
OR
      <cr_lf>1101,1101,1101<cr_lf> //Multipoint with 3 channels
```

21 GET SPECIFIC TRANSMISSION CHANNEL

Set Using: ATSWC

	<p>Return Parameters: <Selected>,<Channel> EXAMPLE: TYPE : ATSI,21<cr> REPLY: <cr_lf>OK<cr_lf> <cr_lf>01,03<cr_lf></p> <p>22 GET FTP/OPP CONNECTION STATUS Return Parameters: <Connection Status> Connection Status: 0 = Disconnected, 1 = Connected EXAMPLE: TYPE : ATSI,22<cr> REPLY: <cr_lf>OK<cr_lf> <cr_lf>1<cr_lf></p>
--	---

3.4.2 Boot Mode

SSW,1	<p>SET BOOT MODE</p> <p>Function: Sets the boot mode.</p> <p>Format: ATSSW,1,<Boot Mode></p> <p>Parameters:</p> <ul style="list-style-type: none"> ▪ <i>Boot Mode:</i> <ul style="list-style-type: none"> 0 = VM Mode // Default baud rate = 9600, 8-N-1 1 = HCI Mode // Fixed baud rate = 115.2k, 8-N-1 2 = BCSP Mode // Fixed baud rate = 115.2k, 8-N-1 <p>Factory Default: VM Mode</p> <p>EXAMPLE: TYPE : ATSSW,1,1<cr> REPLY: <cr_lf>OK<cr_lf> OR <cr_lf>ERROR<cr_lf></p> <p>Read Using: ATRSW,1</p> <p><i>Note: All AT Commands work only with the VM.</i></p>
RSW,1	<p>READ BOOT MODE</p> <p>Function: Gets the boot mode.</p> <p>Format: ATRSW,1</p> <p>Return Parameters: <Boot Mode></p> <p>EXAMPLE: TYPE : ATRSW,1<cr> REPLY: <cr_lf>OK<cr_lf></p>

<cr_lf>00<cr_lf>

Set Using: ATSSW,1

3.4.3 Security Level

SSW,2	<p>SET SECURITY LEVEL</p> <p>Function: Sets the Security Level register state.</p> <p>Format: ATSSW,2,<Security Level></p> <p>Parameters:</p> <ul style="list-style-type: none"> ▪ <i>Security Modes:</i> <ul style="list-style-type: none"> 0 = Link Level - Highest level of security. 1 = Service Level - Provides service information without using PIN. <p>Factory Default: VM Mode</p> <p>EXAMPLE:</p> <pre>TYPE : ATSSW,2,1<cr> REPLY: <cr_lf>OK<cr_lf> OR <cr_lf>ERROR<cr_lf></pre> <p>Read Using: ATRSW,2</p>
RSW,2	<p>SECURITY LEVEL</p> <p>Function: Gets the Security level register state.</p> <p>Format: ATRSW,2</p> <p>Return Parameters: <Boot Mode></p> <p>EXAMPLE:</p> <pre>TYPE : ATRSW,2<cr> REPLY: <cr_lf>OK<cr_lf> <cr_lf>00<cr_lf></pre> <p>Set Using: ATSSW,2</p>

3.4.4 Maximum Number of *Bluetooth* Connections

SSW,3	<p>SET MAX CONNECTION NUMBER</p> <p>Function: Sets the maximum number of Bluetooth connections. Enables multi-point mode if number of connections is greater than one.</p>
--------------	--

	<p>Format: ATSSW,3,<Number of Connections></p> <p>Parameters:</p> <ul style="list-style-type: none"> ▪ <i>Number of Connections:</i> Integer Value 1-4 <p>Factory Default: 1</p> <p>EXAMPLE:</p> <p>TYPE : ATSSW,3,1<cr> REPLY: <cr_lf>OK<cr_lf></p> <p>Notes:</p> <ul style="list-style-type: none"> ▪ <i>Fast Data Mode is only supported with 1 connection and ##,00 packet header is never sent. It is recommended you limit the number of connections for your application to maximize performance and security.</i> ▪ <i>Requires a reset for change to take affect.</i> ▪ <i>By default data is broadcast to all connected radios when the local radio is in data mode. The radio can be set to transmit to a specific channel using the ATSWC command. (See the Utilities section for more information)</i>
RSW,3	<p>READ MAX CONNECTION NUMBER</p> <p>Function: Reads the maximum number of Bluetooth connections.</p> <p>Format: ATRSW,3</p> <p>Return Parameters: <Max Connections></p> <p>EXAMPLE:</p> <p>TYPE : ATRSW,3<cr> REPLY: <cr_lf>OK<cr_lf> <cr_lf>01<cr_lf></p>

3.4.5 Set and Read Radio Name

When another Radio performs a discovery, this will be the name that is passed to that radio. Please take note, unlike the name, the Radio's *Bluetooth* address is fixed (48bit) at the factory and is unique to every *Bluetooth* device manufactured.

SN	<p>SET RADIO NAME</p> <p>Function: Sets the local radio's friendly name.</p> <p>Format: ATSN,<Name></p>
----	--

	<p>Parameters:</p> <ul style="list-style-type: none"> Name: 16 alphanumeric characters MAX <p>Factory Default: BlueRadios</p> <p>EXAMPLE:</p> <pre>TYPE : ATSN,MYRADIOS_0123456<cr> REPLY: <cr_lf>OK<cr_lf> OR <cr_lf>ERROR<cr_lf></pre> <p>Read Using: ATSI,2</p>
RRN	<p>READ REMOTE RADIO NAME BY BLUETOOTH ADDRESS</p> <p>Function: Gets a remote radio's friendly name using its <i>Bluetooth</i> address.</p> <p>Format: ATRRN,<BT Address></p> <p>Parameters:</p> <ul style="list-style-type: none"> BT Address: <i>Bluetooth</i> Address, 12 hex characters MAX <p>Return Parameters: <Radio Name></p> <p>EXAMPLE:</p> <pre>TYPE : ATRRN,0123456789012<cr> REPLY: <cr_lf>OK<cr_lf> <cr_lf>BlueRadios<cr_lf> OR <cr_lf>NO ANSWER<cr_lf></pre> <p><i>Note: The timeout for this command is controlled by the master connect timeout in ATSW28.</i></p>

3.4.6 Set and Read Service Name for Local and Remote Devices

SSN	<p>SET SERVICE NAME</p> <p>Function: Sets the <i>Bluetooth</i> Service Name of channel 0 on the local device.</p> <p>Format: ATSSN,<Service Name></p> <p>Parameters:</p> <ul style="list-style-type: none"> Service Name: 16 alphanumeric characters MAX <p>Factory Default: "COM0"</p> <p>EXAMPLE:</p> <pre>TYPE : ATSSN,COM0<cr> REPLY: <cr_lf>OK<cr_lf></pre>
-----	---

	<p>OR <cr_lf>ERROR<cr_lf></p> <p>Read Using: ATSI,4 or ATRSN</p> <p><i>Note: Requires a reset for change to take affect.</i></p>
<p>SSNC</p>	<p>SET SERVICE NAME BY CHANNEL</p> <p>Function: Sets the local <i>Bluetooth</i> Service Name and Service UUID by channel number.</p> <p>Format: ATSSNC,<Channel Number>,<Service Name>,<UUID></p> <p>Parameters:</p> <ul style="list-style-type: none"> ▪ Channel Number: 0, 1, 2, 3 ▪ Service Name: 16 alphanumeric characters MAX ▪ UUID: 4 digit, binary profile code (See Appendix C for more info) <p>Factory Default: "COM0" for Channel 0, "COM1" for Channel 1, "COM2" for Channel 2, "COM3" for Channel 3</p> <p>EXAMPLE:</p> <p>TYPE : ATSSNC,0,My Device,1101<cr> REPLY: <cr_lf>OK<cr_lf></p> <p>OR <cr_lf>ERROR<cr_lf></p> <p><i>Note: Requires a reset for change to take affect.</i></p>
<p>RSN</p>	<p>READ SERVICE NAME</p> <p>Function: Reads the local <i>Bluetooth</i> Service Name.</p> <p>Format: ATRSN</p> <p>Return Parameters: <Service Name></p> <p>EXAMPLE:</p> <p>TYPE : ATRSN<cr> REPLY: <cr_lf>OK<cr_lf><cr_lf>COM0<cr_lf></p>
<p>RSNC</p>	<p>READ SERVICE NAME BY CHANNEL</p> <p>Function: Reads the local <i>Bluetooth</i> Service Name by channel number.</p> <p>Format: ATRSNC,<Channel Number></p> <p>Parameters:</p> <ul style="list-style-type: none"> ▪ Channel Number: 0-3 <p>Return Parameters: <Service Name></p>

	<p>EXAMPLE: <i>TYPE</i> : ATRSNC,0<cr> <i>REPLY</i>: <cr_lf>OK<cr_lf><cr_lf>COM0<cr_lf></p>
RRSN	<p>READ REMOTE SERVICE NAME</p> <p>Function: Reads a remote <i>Bluetooth</i> device Service Name and Service Channel Number for a specific profile.</p> <p>Format: ATRRSN,<BT Address>,<UUID></p> <p>Parameters:</p> <ul style="list-style-type: none"> ▪ <i>BT Address</i>: <i>Bluetooth</i> Address, 12 hex characters MAX ▪ <i>UUID</i>: 4 digit, binary profile code (See Appendix C for more info) <p>Return Parameters: <Service Channel Number>,<Service Name></p> <p>EXAMPLE: <i>TYPE</i> : ATRRSN,123456789012,1101<cr> <i>REPLY</i>: <cr_lf>OK<cr_lf> <cr_lf>01,Bluetooth Serial Port<cr_lf> <cr_lf>02,Bluetooth Serial Port (2)<cr_lf> OR <cr_lf>NO ANSWER<cr_lf></p> <p><i>Note: The timeout for this command is controlled by the master connect timeout in ATSW28.</i></p>

3.4.7 Security PIN Settings

SSW,6	<p>SET PIN REQUEST HANDLING MODE</p> <p>Function: Sets the PIN (Personal Identification Number) request handling mode. If set to 0 the PIN stored using the ATSP command will automatically be used during PIN exchanges. If set to 1 the prompt "PIN REQUEST" will be output by the radio and the user will need to manually enter a PIN using the ATPR command.</p> <p>Format: ATSSW,6,<Mode></p> <p>Parameters:</p> <ul style="list-style-type: none"> ▪ <i>Mode</i>: <ul style="list-style-type: none"> 0 = Automatic PIN Request Handling 1 = Manual PIN Request Handling <p>Factory Default: 0</p> <p>EXAMPLE: <i>TYPE</i> : ATSSW,6,1<cr></p>
-------	---

	<p>REPLY: <code><cr_lf>OK<cr_lf></code> OR <code><cr_lf>ERROR<cr_lf></code></p> <p>Read Using: ATRSW,6</p> <p><i>Note: Requires a reset for change to take affect.</i></p>
<p>RSW,6</p>	<p>READ PIN REQUEST HANDLING MODE</p> <p>Function: Reads the PIN request handling mode.</p> <p>Format: ATRSW,6</p> <p>Return Parameters: <Mode></p> <p>EXAMPLE: TYPE : ATRSW,6<cr> REPLY: <code><cr_lf>OK<cr_lf></code> <code><cr_lf>00<cr_lf></code></p> <p>Set Using: ATSSW,6</p>
<p>SP</p>	<p>SET PIN</p> <p>Function: Sets the PIN to be used with automatic PIN request handling.</p> <p>**Warning** Be careful when entering a new PIN. There is no way to obtain PIN status after it is changed. If the PIN is changed after two units have already authenticated and connected you will have perform a software or hardware reset for the devices to use the new PIN's if not the two units will still connect using the old stored PIN.</p> <p>Format: ATSP,<New PIN>,<Old PIN></p> <p>Parameters:</p> <ul style="list-style-type: none"> ▪ <i>New PIN:</i> 16 alphanumeric characters MAX (Caps Sensitive, includes spaces) ▪ <i>Old PIN:</i> 16 alphanumeric characters MAX (Caps Sensitive, includes spaces) <p>Factory Default: default</p> <p>EXAMPLE: TYPE : ATSP,1234567890123456,default<cr> REPLY: <code><cr_lf>OK<cr_lf></code> OR <code><cr_lf>ERROR<cr_lf></code></p> <p><i>Note: If security is enabled in multipoint mode, all connected slaves will have to use the same PIN. There is no way to assign an individual PIN to each slave.</i></p>

OP	<p>OVERWRITE PIN</p> <p>Function: Overwrites the stored PIN without needing the old PIN. To use this command the PIN must be unlocked using ATSW29.</p> <p>Format: ATOP,<PIN></p> <p>Parameters:</p> <ul style="list-style-type: none"> ▪ <i>PIN</i>: 16 alphanumeric characters MAX (Caps Sensitive, includes spaces) <p>EXAMPLE:</p> <pre>TYPE : ATOP,1234<cr> REPLY: <cr_lf>OK<cr_lf> OR <cr_lf>ERROR<cr_lf> //If ATOP has not been enabled with ATSW29</pre>
ATPR	<p>RESPOND TO MANUAL PIN REQUEST</p> <p>Function: Allows the user to manually enter a PIN after receiving the PIN REQUEST prompt from the radio.</p> <p>Format: ATPR,<PIN></p> <p>Parameters:</p> <ul style="list-style-type: none"> ▪ <i>PIN</i>: 16 alphanumeric characters MAX (Caps Sensitive, includes spaces) <p>EXAMPLE:</p> <pre>REPLY: <cr_lf>PIN REQUEST<cr_lf> TYPE : ATPR,default<cr> REPLY: <cr_lf>OK<cr_lf> OR <cr_lf>ERROR<cr_lf></pre>

3.4.8 Class of Device (COD)

SC	<p>SET COD</p> <p>Function: Sets the COD.</p> <p>Format: ATSC,<COD></p> <p>Parameters:</p> <ul style="list-style-type: none"> ▪ <i>COD</i>: Exactly 8, 16-bit hex values (0 thru F) based on the <i>Bluetooth</i> COD specification names published and maintained by the <i>Bluetooth</i> SIG. <p>Factory Default: 00000000 - Which is undefined since this is set by the user based on the final OEM device it is installed in.</p> <p>EXAMPLE:</p> <pre>TYPE : ATSC,00020114<cr></pre>
-----------	--

REPLY: <cr_lf>OK<cr_lf>
OR
<cr_lf>ERROR<cr_lf>

Read Using: ATSI,5

Note: Requires a reset for change to take affect.

3.4.9 Write Memory Locations (S Registers) – Radio Configuration

S registers refer to memory locations used for configuration. The SW commands are used to assign values to various registers in the radio's flash memory that are stored in nonvolatile memory.

SW20 WRITE UART SETTINGS

Function: Configures UART settings.

Format: ATSW20,<Baudrate>,<Parity>,<Stop Bits>,<Store>

Parameters:

- *Baudrate:* 1200 - 921.6Kbps, enter Ascii Value from table below.

****Contact BlueRadios for calculating and setting custom baud rates not listed in the table. As long as the the equation BAUDRATE *0.004096 produces an integer value, then there will be 0% error in clocking for the baud rate.**

Baudrate	Ascii Value	Error
No Change	0	-
1200	5	1.73%
2400	10	1.73%
4800	20	1.73%
9600	39	-0.82%
19.2k	79	0.45%
38.4k	157	-0.18%
57.6k	236	0.03%
115.2k	472	0.03%
230.4k	944	0.03%
460.8k	1887	-0.02%
921.6k	3775	0.00%

- *Parity:*
 - 0 = None
 - 1 = Odd
 - 2 = Even
- *Stop Bits:*
 - 0 = One

1 = Two

- *Store Parameters:*
 - 0 = Do Not Store
 - 1 = Store Parameters in Flash

Factory Default: Baudrate = 39, Parity = 0, Stop Bits = 0 (8, N, 1 w/ hardware flow control RTS/CTS enabled)

EXAMPLE:

TYPE : ATSW20,39,0,0,1<cr> // 9600 8,N,1 store in flash
REPLY: This unique Command does not reply with "OK" or "ERROR" because of internal UART data processing limitations and response timing.

Read Using: ATSI,8

Notes:

- *Flow control is always enabled, short CTS/RTS together if not used.*
- *The RTS line of the radio will be low when the radio is ready to receive data and high when its buffer is full. When RTS goes high wait until it returns to low before sending more data to avoid losing information.*
- *To reconfigure radio back to default factory settings apply 3.3vdc on PIO#4 during initial power up for >2sec.*

SW21 WRITE SLAVE SCAN INTERVALS AND WINDOWS

****Warning**** Setting these will affect the inquiry and connection time. You could inadvertently set the scan interval too long and the window too short on the slave for a master connect request. Unless your application is battery powered slave and power conservation is critical leave at the factory default settings. The minimum Window allowed by the Bluetooth spec is 11.25msec. If you set isWindow = 0 the Slave device will not be discovered by any Master but you can still use the Slaves BT address and connect directly to it from a remote Master.

Function: Configures Page Scan and Inquiry Scan Interval and Window for disconnected slave devices in time slots.

Format: ATSW21,<psInterval>,<psWindow>,<isInterval>,<isWindow>

Parameters:

- *psInterval: Page Scan Interval*
Integer Value 18 to 4096 (11.25ms to 2560ms), 0=Disabled
Time [ms] = psInterval * 0.625ms
- *psWindow: Page Scan Window*
Integer Value 18 to 4096 (11.25ms to 2560ms), 0=Disabled
Time [ms] = psWindow * 0.625ms
- *isInterval: Inquiry Scan Interval*
Integer Value 18 to 4096 (11.25ms to 2560ms), 0=Disabled

	<p>Time [ms] = isInterval * 0.625ms</p> <ul style="list-style-type: none">▪ <i>isWindow: Inquiry Scan Window</i> Integer Value 18 to 4096 (11.25ms to 2560ms), 0=Disabled Time [ms] = isWindow * 0.625ms <p>Factory Default: <i>psInterval = 1024(640ms), psWindow = 512(320ms), isInterval = 1024(640ms), isWindow = 512(320ms)</i></p> <p>EXAMPLE: <i>TYPE : ATSW21,4096,18,4096,18<cr></i> <i>REPLY: <cr_lf>OK<cr_lf></i> OR <i><cr_lf>ERROR<cr_lf></i></p> <p>Read Using: ATSI,10</p> <p>Notes:</p> <ul style="list-style-type: none">▪ <i>Requires a reset for the settings to go into affect.</i>▪ <i>ATSW21,4096,18,4096,18 settings will result in a current draw for an unconnected slave of ~1mA average vs. 39mA average at default.</i>▪ <i>ATSW21,4096,18,4096,18 settings along with enabling Deep Sleep Mode will result in an unconnected slave current draw of ≈ 350uA average.</i>
<p>SW22</p>	<p>WRITE PIO DIRECTION</p> <p>**Warning** This command has to be issued before using PIO's as outputs. Inputting 3.3Vdc into a PIO assigned as output will permanently damage the radio.</p> <p>Function: Configures direction of PIO's.</p> <p>Format: ATSW22,<PIO#>,<PIO State>,<Store></p> <p>Parameters:</p> <ul style="list-style-type: none">▪ <i>PIO#:</i> 3,6,7 (6 & 7 not user definable in MP mode, see notes below)▪ <i>PIO State:</i> 0 = Input 1 = Output▪ <i>Store:</i> 0 = Do Not Store 1 = Store Parameters in Flash <p>EXAMPLE: <i>TYPE : ATSW22,6,0,1<cr></i> <i>REPLY: <cr_lf>OK<cr_lf></i> OR <i><cr_lf>ERROR<cr_lf></i></p>

Notes:

Point to Point PIO Functionality

- *PIO(2) Hard coded as output only. Indicates Bluetooth connection on Ch00.*
- *PIO(3) Hard coded as input only. High signal of > 1ms will interrupt to wake-up CPU out of deep sleep mode if enabled.*
- *PIO(4) Hard coded as input only, Triple Purpose PIO. Used for resetting factory defaults on power up and breaking out of Fast Data mode while Bluetooth connected. Also if strobed will auto connect to last paired or last connected device.*
- *PIO(5) Hard coded as output only. Strobes to indicate slave or master inquiry in process.*
- *PIO(6) **User Definable**. Defaults as input.*
- *PIO(7) **User Definable**. Defaults as input.*

Multi Point PIO Functionality

- *PIO(2) Hard coded as output only. Indicates Bluetooth connection on Ch00.*
- *PIO(3) Hard coded as input only. Defaults as input, high signal of > 1ms will interrupt to wake-up CPU out of deep sleep mode if enabled.*
- *PIO(4) Hard coded as input only, Triple Purpose PIO. Used for resetting factory defaults on power up and breaking out of Fast Data mode while Bluetooth connected. Also if strobed will auto connect to last paired or last connected device.*
- *PIO(5) Hard coded as output only. Indicates Bluetooth connection on Ch01.*
- *PIO(6) **User definable if no connection on Channel 2**. Indicates Bluetooth connection on Ch02.*
- *PIO(7) **User definable if no connection on Channel 3**. Indicates Bluetooth connection on Ch03.*

SW23 WRITE PIO LEVEL

Function: Sets PIO logic level.

Format: ATSW23,<PIO#>,<Value>,<Store>

Parameters:

	<ul style="list-style-type: none"> ▪ <i>PIO#</i>: 3,6,7 (6 & 7 not user controllable in MP mode, see notes above in ATSW22) ▪ <i>PIO State</i>: <ul style="list-style-type: none"> 0 = Off (0V) 1 = On (+V) ▪ <i>Store</i>: <ul style="list-style-type: none"> 0 = Do Not Store 1 = Store Parameters in Flash <p>EXAMPLE: <i>TYPE</i> : ATSW23,6,1,1<cr> <i>REPLY</i>: <cr_lf>OK<cr_lf> OR <cr_lf>ERROR<cr_lf></p> <p>Read Using: ATSR21</p>
<p>SW24</p>	<p>WRITE RESPONSE, SECURITY, AUTO SCO, FILTER SETTINGS</p> <p>Function: Configures response, security, auto sco, and filter settings.</p> <p>Format: ATSW24,<Response Type>,<Security>,<Auto SCO>,<Minor Filter></p> <p>Parameters:</p> <ul style="list-style-type: none"> ▪ <i>Response Type</i> (See Appendix B for more information): <ul style="list-style-type: none"> 0 = Long Response 1 = Short Response 2 = No Verbose Mode (No unsolicited responses will be output) <ul style="list-style-type: none"> - No OKs will come back, but requested information such as ATSI, ATRSW, ATRSN and ATDI responses will. - The radio will not output CONNECT or DISCONNECT messages. - In FTP and OPP modes the radio will still output all necessary messages such as PUSH START and PUSH COMPLETE. ▪ <i>*Security</i>: 56bit encryption is automatically enabled when set to 1. UART will reply PAIRED,<BT Address> before the CONNECT,<BT Address> is returned when a connection is made. <ul style="list-style-type: none"> 0 = No Authorization 1 = Authorization Required ▪ <i>Auto SCO</i>: <ul style="list-style-type: none"> 0 = No Automatic SCO Connect 1 = SCO Auto Connect Upon Radio Connect. ▪ <i>**Minor Filter</i>: <ul style="list-style-type: none"> 0 = Disable Minor COD Filter on Inquiry 1 = Enable Minor COD Filter on Inquiry <p>Factory Default: <i>Response Type</i> = 0, <i>Security</i> = 0, <i>Auto SCO</i> = 0, <i>Filter</i> = 0</p>

EXAMPLE:

TYPE : ATSW24,0,0,0,0<cr>
REPLY: <cr_lf>OK<cr_lf>
OR
<cr_lf>ERROR<cr_lf>

Read Using: ATSI,6

Notes:

- See Appendix B for differences between short response and long response mode.
- Requires a reset for security to go into affect.
- *If security is enabled in multipoint mode, all connected slaves will have to use the same PIN. There is no way to assign an individual PIN to each slave.
- **With the minor filter enabled, inquiry results are filtered by the lower 2 bytes of the COD. If the minor filter is disabled all devices are found.

SW25 WRITE CONNECTION, COMM, UNCONNECTED UART, DEFAULT SERVICE MODES

****Warning**** The only way to communicate to the radio after setting the radio in "Fast Data Mode" and "ignore UART while unconnected" is to apply 3.3Vdc on PIO(4) during initial power up for >2 sec. These settings are used if you have no control over the source of streaming data into the radio, or you do not know when the radio has made a *Bluetooth* connection, and do not plan on sending any AT commands.

Function: Configures connection, comm, unconnected UART and default service modes.

Format: ATSW25,<Power-Up Connection Mode>,<Comm Mode>,<Unconnected UART Mode>,<Default Service Profile>

Parameters:

- *Power-Up Connection Mode:*
 - 0 = Slave
 - 1 = Auto-Master (Set ATSMa Command First)*
 - 2 = Idle Mode**
 - 3 = Slave Undiscoverable
 - 5 = Repeater (Set ATSMa Command First)***
 - 6 = Mesh Configuration
 - 7 = OPP Server (See FTP and OPP Modes Section for more info)
 - 8 = FTP Server (See See FTP and OPP Modes Section for more info)
- *Comm Mode:*
 - 0 = Fast Data****
 - 1 = Data
 - 2 = Command

- *Unconnected UART Mode:*
0 = Allow Data to Pass While Unconnected
1 = Ignore Data While Unconnected
- *Default Service Profile: This field has no longer has any effect, it can just be set to 0. Service profile UUIDs are now set using the ATSSNC command.*

Factory Default: Connection Mode = 0, Comm Mode = 1, Unconnected UART Mode = 0, Default Service Profile = 0

EXAMPLE:

```
TYPE : ATSW25,0,1,0,0<cr> //Slave radio connects in fast data mode
REPLY: <cr_lf>OK<cr_lf>
OR
      <cr_lf>ERROR<cr_lf>
```

Read Using: ATSI,7

Notes:

- *Requires a reset for the settings to go into affect.*
- **Auto-Connect Master always connects using the highest available channel. If none available it will continue to retry.*
- ***In idle mode the radio is neither slave nor master and draws 1.6mA of current but you can not communicate over the Bluetooth link in this state only through the TX & RX hardware UART.*
- ****Repeater always uses channel 00 for slave and 01 for Master.*
- *****If data mode is set to "Fast Data Mode" in a Master unit during a manual inquiry "ATDI" and/or connection request the radio connects in slow data mode not fast. This is because you will need the capability to issue commands because in fast data mode the AT command parser is turned off.*
- *The comm mode parameter has no effect when operating in FTP or OPP mode.*

SW26 LOCK USER SETTINGS

****Warning**** This command will lock the PIN.

Function: Locks user settings to prevent unauthorized local & remote access.

Format: ATSW26,<PIN>,<Lock/Unlock>

Parameters:

- *PIN:* 16 alphanumeric characters MAX (Caps Sensitive, includes spaces)
- *Lock/Unlock:*
0 = Unlocked
1 = Locked

	<p>Factory Default: Unlocked</p> <p>EXAMPLE: <i>TYPE : ATSW26,default,1<cr></i> <i>REPLY: <cr_lf>OK<cr_lf></i> OR <i><cr_lf>ERROR<cr_lf></i></p> <p><i>Note: ATSW26 will still work after locking the user settings, allowing them to be unlocked.</i></p>
<p>SW27</p>	<p>WRITE LED RATE</p> <p>Function: Sets the LED Pulse Rate on PIO(5).</p> <p>Format: ATSW27,<Pulse Period></p> <p>Parameters:</p> <ul style="list-style-type: none"> ▪ <i>Pulse Rate:</i> Integer decimal value from 1ms to 60,000ms <p>Factory Default: 1000</p> <p>EXAMPLE: <i>TYPE : ATSW27,1000<cr></i> //1000 ms <i>REPLY: <cr_lf>OK<cr_lf></i> OR <i><cr_lf>ERROR<cr_lf></i></p> <p>Read Using: ATSI,11</p> <p><i>Note: Used to indicate slave mode operation and inquiry in process. Duty cycle equals 50%.</i></p>
<p>SW28</p>	<p>WRITE INQUIRY AND MASTER TIMEOUT SETTINGS</p> <p>Function: Configures inquiry and master connect timeout settings.</p> <p>Format: ATSW28,<Inquiry Timeout>,<Master Connect Request Timeout></p> <p>Parameters:</p> <ul style="list-style-type: none"> ▪ <i>Inquiry Timeout:</i> Integer value from 1 to 40 [seconds] ▪ <i>Master Connect Request Timeout:</i> Integer value from 1 to 40 [seconds] <p>Factory Default: <i>Inquiry Timeout = 16, Master Connect Request Timeout = 40</i></p> <p>EXAMPLE: <i>TYPE : ATSW28,16,40<cr></i> // factory default <i>REPLY: <cr_lf>OK<cr_lf></i> OR <i><cr_lf>ERROR<cr_lf></i></p> <p>Read Using: ATSI,13</p>

	<p>Notes:</p> <ul style="list-style-type: none"> ▪ Due to a CSR bug, this command will accept values up to 40, but the actual timeouts will never go over approximately 22 seconds. ▪ The master connect request timeout also controls the timeouts on the ATRRN, ATRRSN and ATPAIR commands.
<p>SW29</p>	<p>WRITE PIN LOCK MODE</p> <p>Function: Configures PIN lock setting.</p> <p>Format: ATSW29,<PIN>,<Lock Mode></p> <p>Parameters:</p> <ul style="list-style-type: none"> ▪ PIN: 16 alphanumeric characters MAX (Caps Sensitive, includes spaces) ▪ Lock Setting: <ul style="list-style-type: none"> 0 = In Normal operation ATOP is disabled 1 = Allow ATOP through UART only 2 = Allow ATOP through UART and over RF Link <p>Factory Default: 0</p> <p>EXAMPLE:</p> <pre>TYPE : ATSW29,default,1<cr> REPLY: <cr_lf>OK<cr_lf> OR <cr_lf>ERROR<cr_lf></pre> <p>Read Using: ATSI,15</p> <p><i>Note: This command enables ATOP, described in the Security PIN Settings section.</i></p>
<p>SW30</p>	<p>WRITE DEEP SLEEP MODE</p> <p>Function: Configures deep sleep mode.</p> <p>Format: ATSW30,<Deep Sleep Mode></p> <p>Parameters:</p> <ul style="list-style-type: none"> ▪ Deep Sleep Mode: <ul style="list-style-type: none"> 0 = Normal Operation never go into deep sleep 1 = Go into deep sleep whenever possible (While idle, page scan or sniff mode) <p>Factory Default: 0</p> <p>EXAMPLE:</p> <pre>TYPE : ATSW30,1<cr> REPLY: <cr_lf>OK<cr_lf> OR <cr_lf>ERROR<cr_lf></pre>

Read Using: ATSI,16

Notes:

- *When the radio is in deep sleep you can not discover or connect to it.*
- *The UART RX line needs to be pulled high if not active before power is applied to the radio module.*
- *If there is an active UART RF link the device will need Sniff Mode enabled to allow it to drop into sleep mode when there is no traffic.*
- *When in deep sleep, the UART will miss the first character while waking up. Send a preamble byte to allow it to wake up and immediately thereafter send the AT Command or data in less than 1 second or the device will go back to deep sleep again. If you are using PIO(3) CPU interrupt a preamble byte is not needed.*
- *No bytes are lost if sending commands down over the remote RF link side.*
- *This setting is stored in flash and does not require a reset to take affect. Takes approx. 1 second before the current will drop down to 25-50uA. Allow 5msec. for the CPU unit to come out of deep sleep.*
- *ATSW21,4096,18,4096,18 settings along with enabling Deep Sleep Mode will result in an unconnected slave current draw of \approx 350uA average.*

3.4.10 Read Memory Locations (S Registers)

S registers refer to memory locations used for configuration. The SR commands are used to read values from various registers in the radio's Flash Memory that are stored in nonvolatile memory.

SR21	<p>READ PIO LEVEL</p> <p>Function: Reads PIO logic level.</p> <p>Format: ATSR21,<PIO#></p> <p>Parameters:</p> <ul style="list-style-type: none"> ▪ <i>PIO#:</i> 2-7 <p>Return Parameters: <Logic Level></p> <p>EXAMPLE:</p> <pre>TYPE : ATSR21,3<cr> REPLY: <cr_lf>OK<cr_lf> <cr_lf>1<cr_lf></pre> <p>Set Using: ATSW23</p>
-------------	---

3.5 Inquiry/Connect/Disconnect Commands

3.5.1 Inquiry Commands

The inquiry command is used to discover all *Bluetooth* radios (within range) that match a certain Class of Device (COD). If the COD is not known it is best to use 00000000 which allows discovery of all devices. You can not be in the default slave mode and perform an inquiry command. Only a Master or a Radio in idle mode can perform an inquiry.

DI	<p>INQUIRE</p> <p>Function: Inquire Command. Used to discover other Bluetooth devices.</p> <p>Format: ATDI,<Max Radios to Discover>,<COD></p> <p>Parameters:</p> <ul style="list-style-type: none">▪ <i>Max Radios to Discover:</i> 0-60,000▪ <i>*COD:</i> Exactly 8, 16-bit hex values (0 thru F) based on the <i>Bluetooth</i> COD specification names published and maintained by the <i>Bluetooth</i> SIG. <p>Return Parameters: <BT Address>,<COD> (Repeated by number of radios found)</p> <ul style="list-style-type: none">▪ An "OK" is returned immediately following this command. "DONE" will appear after all devices have been found, or an inquiry <i>timeout</i> has occurred while searching for the number of devices specified. <p>EXAMPLE MASTER:</p> <pre>TYPE : ATDI,1,00000000<cr> REPLY: <cr_lf>OK<cr_lf> <cr_lf>00A0961F2023,00000000<cr_lf> <cr_lf>DONE<cr_lf> OR <cr_lf>ERROR<cr_lf></pre> <p>Notes:</p> <ul style="list-style-type: none">▪ Recommend executing an ATUCL command to put the radio in idle mode prior to executing an Inquiry command. See Utilities section.▪ Due to a CSR bug, there is no guarantee that the radios returned by an inquiry will all be unique - duplicates can occur. This seems to happen if the inquiry doesn't discover the maximum number of radios. After discovering all of the radios it can, it will then start to return duplicate radios that it has already discovered until the maximum is reached or the inquiry times out.▪ <i>*With the minor filter enabled using ATSW24, inquiry results are filtered by the lower 4 bytes of the COD. If the minor filter is disabled all devices are found.</i>
-----------	---

	<ul style="list-style-type: none"> The request for friendly name is a separate message request in the new CSR firmware - see ATRRN.
<p>IL</p>	<p>LAST INQUIRY</p> <p>Function: Repeats last inquiry.</p> <p>Format: ATIL</p> <p>Return Parameters: <BT Address>,<COD></p> <ul style="list-style-type: none"> An "OK" is returned immediately following this command. "DONE" will appear after all devices have been found, or an inquiry <i>timeout</i> has occurred while searching for the number of devices specified. <p>EXAMPLE MASTER:</p> <pre>TYPE : ATIL<cr> REPLY: <cr_lf>OK<cr_lf> <cr_lf>00A0961F2023,00000000<cr_lf> <cr_lf>DONE<cr_lf> OR <cr_lf>ERROR<cr_lf></pre> <p><i>Note: ATDI command string previously used is stored in flash memory.</i></p>

3.5.2 Connect as Master

This command is used to connect one radio module to another. Doing this will enable data transmission bi-directionally. When performing this command the reply is critical so as to understand where the connection process is. A connection can take several seconds, so when making a connection, if it is not already connected, an "OK" will be sent back immediately. Don't mistake this for a connection being complete. A completed connection will return "CONNECT,00,123456789012" some time after the command was sent typically <2 seconds. PIO(2) will go high and stay high or the Blue LED on the BlueRadios evaluation board will turn on and stay on while a Bluetooth connection is established on Channel connection 00.

Note: If either the slave or the master of the connection issues a disconnect the radio will output "DISCONNECT." If a connection is lost unexpectedly then "LINKLOSS" will be output.

<p>DM</p>	<p>DIAL AS MASTER</p> <p>Function: This command creates a connection using the Slave's address and UUID profile code.</p> <p>Format: ATDM,<BT Address>,<UUID></p> <p>Parameters:</p> <ul style="list-style-type: none"> BT Address: Bluetooth Address, 12 hex characters MAX UUID: 4 digit, binary profile code (See Appendix C for more info)
------------------	--

Return Parameters: <BT Address> or <Channel Number><BT Address>

POINT TO POINT EXAMPLE:

```
TYPE : ATDM,123456789012,1101<cr>
REPLY: <cr_lf>OK<cr_lf>
      <cr_lf>CONNECT,123456789012<cr_lf>
OR
      <cr_lf>OK<cr_lf>
      <cr_lf>PAIRED,123456789012<cr_lf> // if security is enabled
      <cr_lf>CONNECT,123456789012<cr_lf>
OR
      <cr_lf>NO ANSWER<cr_lf> // if device not present
```

MULTIPOINT EXAMPLE:

```
TYPE : ATDM,123456789012,1101<cr>
REPLY: <cr_lf>OK<cr_lf>
      <cr_lf>CONNECT,00,123456789012<cr_lf>
OR
      <cr_lf>OK<cr_lf>
      <cr_lf>PAIRED,123456789012<cr_lf> // if security is enabled
      <cr_lf>CONNECT,00,123456789012<cr_lf>
OR
      <cr_lf>NO ANSWER<cr_lf> // if device not present
```

Notes:

- If the remote Slave device is not present or the service is not available, NO ANSWER will reply after the master connect timeout and you will have to try again.
- If security is enabled and the radio is connecting to a PC that has not yet been paired with it, the <cr_lf>PAIRED,12345678912<cr_lf> message may return twice prior to the CONNECT.
- By using the ATDC command connection time will be decreased to approximately 500ms.

DC DIAL CHANNEL

Function: Connects to a remote device by *Bluetooth* address and service channel number (RF Comm ID). This will decrease the connection time to approximately 500ms.

Format: ATDC,<BT Address>,<Service Channel Number>

Parameters:

- *BT Address:* Bluetooth Address, 12 hex characters MAX
- *Remote Service Channel#:* 0-3

Return Parameters: <BT Address> or <Channel Number><BT Address>

POINT TO POINT EXAMPLE:

```
TYPE : ATDC,123456789012,1<cr>
REPLY: <cr_lf>OK<cr_lf>
```

	<pre> <cr_lf>CONNECT,123456789012<cr_lf> OR <cr_lf>OK<cr_lf> <cr_lf>PAIRED,123456789012<cr_lf> // if security is enabled <cr_lf>CONNECT,123456789012<cr_lf> OR <cr_lf>NO ANSWER<cr_lf> // if device not present </pre> <p>MULTIPOINT EXAMPLE:</p> <pre> TYPE : ATDC,123456789012,1<cr> REPLY: <cr_lf>OK<cr_lf> <cr_lf>CONNECT,00,123456789012<cr_lf> OR <cr_lf>OK<cr_lf> <cr_lf>PAIRED, 123456789012<cr_lf> // if security is enabled <cr_lf>CONNECT,00,123456789012<cr_lf> OR <cr_lf>NO ANSWER<cr_lf> // if device not present </pre> <p>Notes:</p> <ul style="list-style-type: none"> ▪ Use the ATRRSN command to get a remote service channel number from another device. ▪ If the remote Slave device is not present or the service is not available, NO ANSWER will reply after the master connect timeout and you will have to try again. ▪ If security is enabled and the radio is connecting to a PC that has not yet been paired with it, the <cr_lf>PAIRED,12345678912<cr_lf> message may return twice prior to the CONNECT.
DL	<p>DIAL LAST</p> <p>Function: Connects to last successful Slave <i>Bluetooth</i> address connection over SPP unless ATDM command was executed then the UUID from the ATDM command will be used.</p> <p>Format: ATDL</p> <p>Return Parameters: <BT Address> or <Channel Number><BT Address></p> <p>POINT TO POINT EXAMPLE:</p> <pre> TYPE : ATDL REPLY: <cr_lf>OK<cr_lf> <cr_lf>CONNECT,123456789012<cr_lf> OR <cr_lf>OK<cr_lf> <cr_lf>PAIRED,123456789012<cr_lf> // if security is enabled <cr_lf>CONNECT,123456789012<cr_lf> OR <cr_lf>OK<cr_lf> <cr_lf>NO ANSWER<cr_lf> // if device not present OR </pre>

	<pre> <cr_lf>ERROR<cr_lf> MULTIPOINT EXAMPLE: TYPE : ATDL REPLY: <cr_lf>OK<cr_lf> <cr_lf>CONNECT,00,123456789012<cr_lf> OR <cr_lf>OK<cr_lf> <cr_lf>PAIRED,123456789012<cr_lf> // if security is enabled <cr_lf>CONNECT,123456789012<cr_lf> OR <cr_lf>OK<cr_lf> <cr_lf>NO ANSWER<cr_lf> // if device not present OR <cr_lf>ERROR<cr_lf> </pre> <p>Notes:</p> <ul style="list-style-type: none"> ▪ To verify the stored address use the ATLAST command below. ▪ If the remote Slave device is not present or the service is not available, NO ANSWER will reply after the master connect timeout and you will have to try again. ▪ If security is enabled and the radio is connecting to a PC that has not yet been paired with it, the <cr_lf>PAIRED,12345678912<cr_lf> message may return twice prior to the CONNECT.
<p>LAST</p>	<p>READ LAST ADDRESS</p> <p>Function: Gets the last connected Bluetooth device address.</p> <p>Format: ATLAST</p> <p>Return Parameters: <BT Address></p> <p>EXAMPLE:</p> <pre> TYPE : ATLAST<cr> REPLY: <cr_lf>OK<cr_lf> <cr_lf>000000000000<cr_lf> // Nothing stored OR <cr_lf>OK<cr_lf> <cr_lf>123456789012<cr_lf> // Last connected BT address </pre>

3.5.3 Set Master Default Bluetooth Address

<p>SMA</p>	<p>SET MASTER DEFAULT ADDRESS</p> <p>Function: This command will set a specific Bluetooth Slave address and service profile into the Master device so on power up the Master will automatically search and connect to a unique Slave device on the highest</p>
-------------------	--

	<p>available channel.</p> <p>Format: AT SMA,<BT Address>,<UUID></p> <p>Parameters:</p> <ul style="list-style-type: none"> ▪ <i>BT Address: Bluetooth Address, 12 hex characters MAX</i> ▪ <i>UUID: 4 digit, binary profile code (See Appendix C for more info)</i> <p>EXAMPLE:</p> <p><i>TYPE : AT SMA,00A0961F904F,1101<cr></i></p> <p><i>REPLY: <cr_lf>OK<cr_lf></i></p> <p style="padding-left: 40px;">OR</p> <p style="padding-left: 40px;"><i><cr_lf>ERROR<cr_lf></i></p> <p>Read Using: AT SI,9</p> <p>Notes:</p> <ul style="list-style-type: none"> ▪ <i>Execute AT SW25 to set the power up connect mode to auto-master before using the above command if still in slave mode.</i> ▪ <i>This command is limited to only one connection. Reset module for change to take affect.</i>
<p>MACLR</p>	<p>MASTER ADDRESS CLEAR</p> <p>Function: Clears stored slave address.</p> <p>Format: AT MACLR</p> <p>EXAMPLE:</p> <p><i>TYPE : AT MACLR<cr></i></p> <p><i>REPLY: <cr_lf>OK<cr_lf></i></p> <p style="padding-left: 40px;">OR</p> <p style="padding-left: 40px;"><i><cr_lf>ERROR<cr_lf></i></p>

3.5.4 Connect as Slave

Note: If either the slave or the master of the connection issues a disconnect the radio will output "DISCONNECT." If a connection is lost unexpectedly then "LINKLOSS" will be output.

<p>DS</p>	<p>DIAL AS SLAVE</p> <p>Function: This command places the Radio in Slave mode where it waits for a connection to occur from a Master.</p> <p>Format: AT DS</p> <p>Return Parameter: OK</p> <p>EXAMPLE SLAVE:</p> <p><i>TYPE : AT DS<cr></i></p> <p><i>REPLY: <cr_lf>OK<cr_lf></i></p>
------------------	--

3.5.5 Disconnect

DH	<p>DIAL HANG UP</p> <p>Function: This command will disconnect the current connection on channel 0.</p> <p>Format: ATDH</p> <p>EXAMPLE:</p> <pre>TYPE : ATDH<cr> REPLY: <cr_lf>OK<cr_lf> <cr_lf>DISCONNECT<cr_lf> OR <cr_lf>ERROR<cr_lf></pre> <p><i>Notes:</i></p> <ul style="list-style-type: none">▪ If you send this command over the RF link to a remote BlueRadios Slave the Slave will disconnect and go into Idle mode not Slave mode by design.▪ If a connection should unexpectedly be lost the response will be <cr_lf>LINKLOSS<cr_lf> instead of <cr_lf>DISCONNECT<cr_lf>.
DHC	<p>DIAL HANG UP BY CHANNEL</p> <p>Function: This command will issue disconnect to the specified channel.</p> <p>Format: ATDHC,<Channel Number></p> <p>EXAMPLE:</p> <pre>TYPE : ATDHC,00<cr> REPLY: <cr_lf>OK<cr_lf> <cr_lf>DISCONNECT,00<cr_lf> OR <cr_lf>ERROR<cr_lf></pre> <p><i>Notes:</i></p> <ul style="list-style-type: none">▪ If you send this command over the RF link to a remote BlueRadios Slave the Slave will disconnect and go into Idle mode not Slave mode by design.▪ If a connection should unexpectedly be lost the response will be <cr_lf>LINKLOSS,00<cr_lf> instead of <cr_lf>DISCONNECT,00<cr_lf>.

3.6 Command/Data Modes

1) Fast Data Mode

Fast data mode is currently only supported in point to point mode only. There is no such feature in the ATMP Multi-Point code implementation since the parser needs to be on.

The drawback to this is that once in fast data mode there are limited ways to get out of it like CPU reset, power down, or strobing PIO(4) for >5ms. The advantage of this mode is that the data being sent does not have to be evaluated or processed for AT commands and will allow for a faster effective data throughput of around 250Kbps. To verify you are in fast data mode type `+++<cr>` it will pass directly through the UART because the AT Command parser is off. Else the `+++<cr>` will be accepted because the AT Command parser is still on and returns "OK". On the previous 4Mbit legacy modules the escape characters was fixed and set to "ATMC", is no longer implemented.

2) Command/Data Mode

The Command Mode or Data Mode will slow down the throughput when the radio looks for the AT commands. One way to allow minimal overhead transmission burden is to perform all configuration commands, and then place the radio into the fast data mode.

Note: *Byte Gaps and Data Latency – The way Bluetooth is designed and operates random byte gaps of 5 msec to 20 ms are common. Packet size will vary from transmission to transmission. The faster the UART speed the smaller the byte gap delay.*

Effective data payload throughput in fast data mode is approximately 250Kbps and 35Kbps in regular data mode when the AT parser looks at each character for ASCII valid command scripts in the data stream. The radio RX has very limited buffering so if you do not use hardware flow control and are transmitting further distances you will quickly overflow the buffer because of RF retransmissions, etc.

When a Bluetooth connection is made the radio modem goes into regular data mode per the power-up factory default settings. This enables the user to remotely configure the radio settings via a remote RF Bluetooth connection. Basically you can setup the radio so no commands are required to be sent from the embedded side of the radios UART. This will prevent any software embedded firmware development or testing for legacy systems.

+++	<p>PUT RADIO INTO COMMAND MODE</p> <p>Function: This sequence is used to force the radio into command mode state. If the Radio has been placed in Fast Data Mode this command will have no affect and the typed command will be treated as data. When using this command allow at least 100ms delay before sending the next AT command.</p> <p>Format: +++</p> <p>Return Parameters: If successful an "OK" is returned, or nothing will be returned if already in data or fast data mode, and connected.</p> <p>EXAMPLE:</p> <p>TYPE : +++<cr> REPLY: <cr_lf>OK<cr_lf></p> <p><i>Note: This command is only required if the module is RF CONNECTED, it has not effect if the module is not connected or if it is connected in Fast Data Mode.</i></p>
SESC	<p>SET COMMAND MODE ESCAPE CHARACTER</p> <p>Function: Sets the radio's escape character, used to put the radio into</p>

	<p>command mode.</p> <p>Format: ATSESC,<ASCII Value></p> <p>Parameter:</p> <ul style="list-style-type: none">▪ <i>ASCII Value:</i> Integer value of a non extended ASCII character <p>Factory Default: 43 = "+"</p> <p>EXAMPLE:</p> <pre>TYPE : ATSESC,43<cr> REPLY: <cr_lf>OK<cr_lf> OR <cr_lf>ERROR<cr_lf></pre>
MD	<p>PUT RADIO INTO DATA MODE</p> <p>Function: Forces the radio into Data Mode. In order for this to have an effect the Radio has to be CONNECTED.</p> <p>Format: ATMD</p> <p>Return Parameters: If successful an "OK" is returned, or nothing will be returned if already in data or fast data mode, and connected. A "NO CARRIER" occurs when the Bluetooth connection has been lost.</p> <p>EXAMPLE:</p> <pre>TYPE : ATMD<cr> REPLY: <cr_lf>OK<cr_lf> OR <cr_lf>NO CARRIER<cr_lf></pre>
MF	<p>PUT RADIO INTO FAST DATA MODE</p> <p>Function: Forces the radio into Fast Data Mode on channel 00 only. Once in Fast Data Mode all commands are treated as data. Ways to get out of this mode are to reset power on the radio, or strobe PIO(4) while connected.</p> <p>Format: ATMF</p> <p>Return Parameters: If successful an "OK" is returned, or nothing will be returned if already in data or fast data mode, and connected. A "NO CARRIER" occurs when the Bluetooth connection has been lost.</p> <p>EXAMPLE:</p> <pre>TYPE : ATMF<cr> REPLY: <cr_lf>OK<cr_lf> OR <cr_lf>ERROR<cr_lf> OR <cr_lf>NO CARRIER<cr_lf></pre> <p><i>Note: StrobePIO(4) >5ms to take radio out of fast data into command mode and maintain the Bluetooth RF connection. If not RF connected will place radio in command mode.</i></p>

3.7 Utilities

3.7.1 Cancel Command

UCL	<p>CANCEL</p> <p>Function: The UCL command tells the radio to cancel inquiry or connect requests commands and then places the radio in Idle Mode. This command can come in handy for a quick exit from commands like inquiry mode if there are no devices in the area and you do not want to wait for an automatic timeout. You can not issue a cancel command while RF connected.</p> <p>This command can also be used to break out of the auto-master connect mode. If executed while connected in this mode, the radio will disconnect and enter idle mode instead of attempting to connect again.</p> <p>Format: ATUCL</p> <p>EXAMPLE:</p> <pre>TYPE : ATUCL<cr> REPLY: <cr_lf>OK<cr_lf> OR <cr_lf>ERROR<cr_lf></pre>
------------	---

3.7.2 Pairing

PAIR	<p>PAIR RADIOS</p> <p>Function: This command tells the radio in Master mode to pair to a specific <i>Bluetooth</i> address.</p> <p>Format: ATPAIR,<BT Address></p> <p>Parameters:</p> <ul style="list-style-type: none">▪ <i>BT Address:</i> Bluetooth Address, 12 hex characters MAX <p>EXAMPLE:</p> <pre>TYPE : ATPAIR,00A0961F008F<cr> REPLY: <cr_lf>OK<cr_lf> <cr_lf>PAIRED,123456789012<cr_lf> OR <cr_lf>ERROR<cr_lf> OR <cr_lf>PAIRED,FAILED<cr_lf></pre>
-------------	--

	<p>Read Using: ATSI,19</p> <p><i>Notes:</i></p> <ul style="list-style-type: none"> ▪ <i>The pairing timeout is 30 seconds.</i> ▪ <i>The radio needs to be in idle mode prior to pairing.</i> ▪ <i>Security PINs are exchanged and must be equal for pairing to complete.</i> ▪ <i>The timeout for this command is controlled by the master connect timeout in ATSW28.</i>
<p>UPAIR</p>	<p>UNPAIR BY INDEX</p> <p>Function: The command tells the radio to unpair from the Bluetooth address stored in index locations 00, 01, 02, and 03.</p> <p>Format: ATUPAIR,<Index></p> <p>Parameters:</p> <ul style="list-style-type: none"> ▪ <i>Index: Index location 00, 01, 02 or 03</i> <p>EXAMPLE:</p> <pre>TYPE : ATUPAIR,00<cr> REPLY: <cr_lf>OK<cr_lf> OR <cr_lf>ERROR<cr_lf></pre> <p><i>Notes:</i></p> <ul style="list-style-type: none"> ▪ <i>Use the command ATLAST to view the stored address after pairing.</i> ▪ <i>Pairing is not the same as a connection, so you will not see inquiry or connectection indication. Can be in Master, Slave, or Idle mode to unpair. Will need to reset or cycle power to clear paired address.</i>
<p>UPAIRB</p>	<p>UNPAIR BY BLUETOOTH ADDRESS</p> <p>Function: This command tells the radio to unpair from the specified Bluetooth address.</p> <p>Format: ATUPAIRB,<BT Address></p> <p>Parameters:</p> <ul style="list-style-type: none"> ▪ <i>BT Address: Bluetooth Address, 12 hex characters MAX</i> <p>EXAMPLE:</p> <pre>TYPE : ATUPAIR,123456789012<cr> REPLY: <cr_lf>OK<cr_lf> OR <cr_lf>ERROR<cr_lf></pre>

CPAIR	<p>CLEAR ALL PAIRED DEVICES</p> <p>Function: This command tells the radio to unpair from all paired devices.</p> <p>Format: ATUPAIRC</p> <p>EXAMPLE: <i>TYPE : ATCPAIR<cr></i> <i>REPLY: <cr_lf>OK<cr_lf></i></p>
--------------	---

3.7.3 Sniff and Park (Connected Slave)

Supported in Point-to-Point mode only!

Low Power Modes Using Sniff

Bluetooth connections are master/slave in nature. A master sends packets and a slave has to acknowledge that packet in the next timeslot. Timeslots in *Bluetooth* are 625 microseconds wide. This implies that a master will always know when packets will be sent and received, which further means it is able to optimize power usage by switching on power hungry circuitry only when needed.

A slave on the other hand does NOT have prior knowledge of when a packet will be received and has to assume that a packet will be received from a master on every receive slot. This means that it has to leave its receiving circuitry on for most of the receive slot duration. The result of this is high power consumption where a slave with no data transmission still consumes around 5mA.

This problem was identified very early in the evolution of *Bluetooth* (especially since headsets spend all their time as a slave in a *Bluetooth* connection) and it was solved by having a mode called Sniff, with appropriate lower layer negotiating protocol.

Sniff mode during connection is basically an agreement between the slave and its master, which data packets will only be, exchanged for N timeslots every M slots. The slave can then assume that it will never be contacted during N-M slots, and so can switch its power hungry circuitry off. The specification goes further by also specifying a third parameter called 'timeout' (T) which specifies 'extra' timeslots that the slave will agree to listen for after receiving a valid data packet. Put another way, if a data packet is received by the slave, then it knows that it MUST carry on listening for at least T more slots. If within that T slot time period another data packet is received, then the timer is restarted. This mechanism ensures low power consumption when there is no data transfer – at the expense of latency. When there is a lot of data to be transferred, it acts as if sniff mode were not enabled.

It is stated above that during sniff mode, a slave listens for N slots every M slots. The *Bluetooth* specification states that a master can have up to 7 slaves attached to it with all slaves having requested varying sniff parameters. It may therefore be impossible to guarantee that each slave gets the M parameter it requested. In light of this, the protocol for enabling sniff mode specifies that a requesting peer specify the M parameter as a minimum and maximum value. This will allow the master to interleave the sniff modes for all slaves attached.

SNIFF	<p>ENABLE SNIFF</p> <p>Function: Manually enables sniff mode for Slave device connected in time</p>
--------------	---

	<p>slots.</p> <p>Format: ATSNIFF,<Max Interval>,<Min Interval>,<Attempt>,<Timeout></p> <p>Parameters:</p> <ul style="list-style-type: none"> ▪ <i>Max Interval:</i> Integer Value Time [ms] = <i>Max Interval</i> * 0.625ms ▪ <i>Min Interval:</i> Integer Value Time [ms] = <i>Min Interval</i> * 0.625ms ▪ <i>Attempt:</i> Integer Value Time [ms] = <i>Attempt</i> * 0.625ms ▪ <i>Timeout:</i> Integer Value Time [ms] = <i>Timeout</i> * 0.625ms <p>EXAMPLE:</p> <p><i>TYPE</i> : ATSNIFF,1600,160,10,160<cr> <i>REPLY</i>: <cr_lf>OK<cr_lf> OR <cr_lf>NO CARRIER<cr_lf></p> <p><i>Notes:</i></p> <ul style="list-style-type: none"> ▪ <i>Manually enable sniff results in an always connected slave using only 2mA average current when no data is sent. Takes about 7 seconds before the current drops after the connection is established. Parameters are lost after connection is dropped.</i> ▪ <i>The radio will exit sniff mode once the connection is terminated, ATSNIFF must be executed again upon establishing a new connection in order to start sniff mode again.</i>
<p>SSNIFF</p>	<p>ENABLE AUTO SNIFF</p> <p>**Warning** Sniff seems to intermittently work using this command. Approximately 1 in 5 connections will not automatically go into sniff mode. Use ATSNIFF to guarantee that sniff mode is started correctly.</p> <p>Function: Stores sniff parameters permanently in flash and auto starts sniff mode after a connection is established.</p> <p>Format: ATSSNIFF,<Max Interval>,<Min Interval>,<Attempt>,<Timeout></p> <p>Parameters:</p> <ul style="list-style-type: none"> ▪ <i>Max Interval:</i> Integer Value Time [ms] = <i>Max Interval</i> * 0.625ms ▪ <i>Min Interval:</i> Integer Value Time [ms] = <i>Min Interval</i> * 0.625ms ▪ <i>Attempt:</i> Integer Value Time [ms] = <i>Attempt</i> * 0.625ms

	<ul style="list-style-type: none"> ▪ Timeout: Integer Value Time [ms] = Timeout * 0.625ms <p>EXAMPLE: TYPE : ATSSNIFF,1600,160,10,160<cr> REPLY: <cr_lf>OK<cr_lf> OR <cr_lf>ERROR<cr_lf></p> <p>Read Using: ATSI,17</p>
CSNIFF	<p>CLEAR SNIFF</p> <p>Function: Clears stored sniff parameters.</p> <p>Format: ATCSNIFF</p> <p>EXAMPLE: TYPE : ATCSNIFF<cr> REPLY: <cr_lf>OK<cr_lf> OR <cr_lf>ERROR<cr_lf></p>
XSNIFF	<p>EXIT SNIFF</p> <p>Function: Tells the radio to exit and stop "sniffing" RF signals.</p> <p>Format: ATXSNIFF</p> <p>EXAMPLE: TYPE : ATXSNIFF<cr> REPLY: <cr_lf>OK<cr_lf> OR <cr_lf>NO CARRIER<cr_lf></p>
PARK	<p>ENABLE PARK</p> <p>Function: Manually enables park mode for device connected in time slots.</p> <p>Format: ATPARK,<Max Interval>,<Min Interval></p> <p>Parameters:</p> <ul style="list-style-type: none"> ▪ Max Interval: Integer Value Time [ms] = Max Interval * 0.625ms ▪ Min Interval: Integer Value Time [ms] = Min Interval * 0.625ms <p>EXAMPLE: TYPE : ATPARK,1000,11<cr> REPLY: <cr_lf>OK<cr_lf> OR <cr_lf>NO CARRIER<cr_lf></p>

	<p>Notes:</p> <ul style="list-style-type: none"> Allow 7 seconds for the slave to drop its average current draw from 45mA to 3mA and go into PARK. Any UART traffic will cause the Slave radio go back to full operation within 5msec of the first character for 7 seconds before going back into PARK mode without subsequent data. The Slave will remain connected to the Master because the BlueRadios Module only supports one connection. Both units are required to support park. Park request is sent from both Master and Slave to go into affect only during an active Bluetooth connection. The order does not matter.
<p>XPARK</p>	<p>EXIT PARK</p> <p>Function: Tells the radio to exit the park mode.</p> <p>Format: ATXPARK</p> <p>EXAMPLE: TYPE : ATXPARK<cr> REPLY: <cr_lf>OK<cr_lf> OR <cr_lf>NO CARRIER<cr_lf></p> <p>Note: Unit will immediately exit park.</p>

3.7.4 RSSI and Link Quality

Golden Receive Power Range

The lower threshold level of the Golden Receive Power Range corresponds to a receive power between -56 dBm and 6 dB above the actual sensitivity of the receiver. The upper threshold level is 20 dB above the lower threshold level to an accuracy of +/-6 dB.

<p>RSSI</p>	<p>GET RSSI VALUE</p> <p>Function: This command is used to obtain the RSSI value for an open connection on channel 0. This is a parameter associated with the ACL connection to a peer device.</p> <p>Format: ATRSSI</p> <p>Return Parameters: <RSSI Value></p> <ul style="list-style-type: none"> RSSI Value is in hex, typically from -10 to +31 in integer dB value. <p>EXAMPLE: TYPE : ATRSSI<cr> REPLY: <cr_lf>OK<cr_lf> <cr_lf>+00<cr_lf> OR</p>
--------------------	--

	<p style="text-align: center;"><cr_lf>ERROR<cr_lf></p> <p>Notes:</p> <ul style="list-style-type: none"> ▪ The RSSI value will be +00 if the signal is within the Golden Range. ▪ The Golden Range min and max value is 1 and 12 respectively for the modules. ▪ This value is the difference between the measured Received Signal Strength Indication (RSSI) and the limits of the Golden Receive Power Range (see below for definition). Any positive RSSI value returned by the Host side indicates how many dB the RSSI is above the upper limit. Any negative value indicates how many dB the RSSI is below the lower limit. A value of zero indicates that the RSSI is inside the Golden Receive Power Range. ▪ How accurate the dB values will be depends on the Bluetooth hardware. The only requirements for the hardware are that the Bluetooth device is able to tell whether the RSSI is inside, above, or below the Golden Device Power Range.
<p>RSSIC</p>	<p>GET RSSI VALUE BY CHANNEL</p> <p>Function: Gets the RSSI Value by channel number.</p> <p>Format: ATRSSIC,<Channel Number></p> <p>Parameters:</p> <ul style="list-style-type: none"> ▪ Channel Number: 0, 1, 2, 3 <p>Return Parameters: <RSSI Value></p> <ul style="list-style-type: none"> ▪ RSSI Value is in hex, typically from -10 to +31 in integer dB value. <p>EXAMPLE:</p> <p>REPLY: <cr_lf>OK<cr_lf> <cr_lf>+00<cr_lf> OR <cr_lf>ERROR<cr_lf></p>
<p>LQ</p>	<p>GET LINK QUALITY</p> <p>Function: Gets the link quality of the current connection.</p> <p>Format: ATLQ</p> <p>Return Parameters: <Link Quality></p> <ul style="list-style-type: none"> ▪ Hex value from 0 to 255 decimal which is the measure of Bit Error Rate (BER) <p>EXAMPLE:</p> <p>TYPE : ATLQ<cr> REPLY: <cr_lf>OK<cr_lf> <cr_lf>FF<cr_lf></p>

	<p>OR</p> <p><cr_lf>ERROR<cr_lf></p> <p><i>Note: Link Quality is a Hex value from 0-255, which represents the quality of the link between two Bluetooth devices. The higher the value, the better the link quality is. Each Bluetooth module vendor will determine how to measure the link quality. In the case for CSR, this value is a measure of BER.</i></p>
LQC	<p>GET LINK QUALITY BY CHANNEL</p> <p>Function: Gets the Link Quality by channel number.</p> <p>Format: ATLQC,<Channel Number></p> <p>Parameters:</p> <ul style="list-style-type: none"> ▪ Channel Number: 0, 1, 2, 3 <p>Return Parameters: <RSSI Value></p> <ul style="list-style-type: none"> ▪ Hex value from 0 to 255 decimal which is the measure of Bit Error Rate (BER) <p>EXAMPLE:</p> <p>TYPE : ATLQ,1<cr></p> <p>REPLY: <cr_lf>OK<cr_lf> <cr_lf>FF<cr_lf></p> <p>OR</p> <p><cr_lf>ERROR<cr_lf></p>

3.7.5 Audio (SCO) PCM Interface

DSCO	<p>DIAL SCO</p> <p>Function: Tells the radio to dial and connect the audio channel.</p> <p>Format: ATDSCO</p> <p>EXAMPLE:</p> <p>TYPE : ATDSCO<cr></p> <p>REPLY: <cr_lf>OK<cr_lf> <cr_lf>SCO CONNECT<cr_lf></p> <p>OR</p> <p><cr_lf>OK<cr_lf> <cr_lf>SCO FAILED<cr_lf></p> <p>OR</p> <p><cr_lf>NO CARRIER<cr_lf></p>
-------------	--

DHSCO	<p>DIAL HANG UP SCO</p> <p>Function: Tells the radio to disconnect the audio channel.</p> <p>Format: ATDHSCO</p> <p>EXAMPLE: <i>TYPE : ATDHSCO<cr></i> <i>REPLY: <cr_lf>OK<cr_lf></i> <i><cr_lf>SCO DISCONNECT<cr_lf></i> OR <i><cr_lf>NO CARRIER<cr_lf></i></p>
--------------	---

3.7.6 Max TX Power

SPF	<p>SET MAX TX POWER LEVEL</p> <p>Format: ATSPF,<Power Level>,<Sign></p> <p>Parameters:</p> <ul style="list-style-type: none"> ▪ <i>Power Level:</i> Integer from 0 to 10 ▪ <i>Sign:</i> + or - (Combined value of level and sign must be in the range of -5 to +10) <p>Typical <i>BlueTooth</i> Industry Values Depending On Device Class Type:</p> <ul style="list-style-type: none"> - Class 1 = 0dBm to +10dBm - Class 2 = -8dBm to +4dBm - Class 3 = 0dBm Max <p><i>BlueRadios</i> Power Table Values:</p> <table style="margin-left: 40px;"> <thead> <tr> <th><u>Class 1 Power Table</u></th> <th><u>Class 2 Power Table "fixed"</u></th> </tr> </thead> <tbody> <tr> <td>-5 dBm</td> <td>0 dBm</td> </tr> <tr> <td>0 dBm</td> <td>0 dBm</td> </tr> <tr> <td>5 dBm</td> <td>0 dBm</td> </tr> <tr> <td>10 dBm</td> <td>0 dBm</td> </tr> </tbody> </table> <p>Factory Default: 10dBm for Class 1 and 0dBm for Class 2 devices.</p> <p>EXAMPLE: <i>TYPE : ATSPF,5,+<cr></i> // +5dBm <i>REPLY: <cr_lf>OK<cr_lf></i> OR <i><cr_lf>ERROR<cr_lf></i></p> <p>Read Using: ATSI,14</p> <p><i>Note: The default value is 0dBm in a class2 BlueRadios module the max performance is still 0dBm output gain for the class2 radio if set above this. This value does not include gains associated with the external antenna (2 dBm). The firmware uses the highest value in the power table that is less</i></p>	<u>Class 1 Power Table</u>	<u>Class 2 Power Table "fixed"</u>	-5 dBm	0 dBm	0 dBm	0 dBm	5 dBm	0 dBm	10 dBm	0 dBm
<u>Class 1 Power Table</u>	<u>Class 2 Power Table "fixed"</u>										
-5 dBm	0 dBm										
0 dBm	0 dBm										
5 dBm	0 dBm										
10 dBm	0 dBm										

than or equal to the requested max transmit power number above.

3.7.7 Link Supervisory Timeout

LSTO	<p>LINK SUPERVISORY TIMEOUT</p> <p>Function: This command tells the radio to drop the connection if the units can not handshake for X amount of time in seconds.</p> <p>Format: ATLSTO,<Time></p> <p>Parameters:</p> <ul style="list-style-type: none"> ▪ <i>Time:</i> Integer value from 2 to 41 <p>Factory Default: 4 (~4s)</p> <p>EXAMPLE:</p> <pre>TYPE : ATLSTO,20<cr> // Sets timeout to ~20 seconds REPLY: <cr_lf>OK<cr_lf> OR <cr_lf>ERROR<cr_lf></pre> <p>Read Using: ATSI,18</p> <p><i>Note: If timeout is set for too short of a duration you may inadvertently drop the connection prematurely if the RF link margin is poor.</i></p>
-------------	---

3.7.8 Variable Storage

STORE	<p>STORE VARIABLE</p> <p>Function: Allows user to permanently store data - ID's, addresses, etc.</p> <p>Format: ATSTORE,<Index>,<String></p> <p>Parameters:</p> <ul style="list-style-type: none"> ▪ <i>Index:</i> <ul style="list-style-type: none"> 0 = Location 0 1 = Location 1 ▪ <i>String:</i> 16 alphanumeric characters MAX <p>EXAMPLE:</p> <pre>TYPE : ATSTORE,0,1234567890123456<cr> REPLY: <cr_lf>OK<cr_lf> OR <cr_lf>ERROR<cr_lf></pre>
--------------	---

READ	<p>READ VARIABLE</p> <p>Function: Allows user to read a stored variable.</p> <p>Format: ATREAD,<Index></p> <p>Parameters:</p> <ul style="list-style-type: none"> ▪ <i>Index:</i> <ul style="list-style-type: none"> 0 = Location 0 1 = Location 1 <p>Return Parameters: <String></p> <p>EXAMPLE: <i>TYPE : ATREAD,0<cr></i> <i>REPLY: <cr_lf>OK<cr_lf></i> <i> <cr_lf>1234567890123456<cr_lf></i></p> <p><i>Note: Nothing stored will return blank</i></p>
-------------	--

3.7.9 Connection PIO Logic

SSW,4	<p>SET CONNECTION PIO LOGIC</p> <p>Function: Sets the connection PIO logic register state. When set to 0, the connection PIO's used to indicate connections (2,5,6 & 7) will be active high. When set to 1, the PIOs used to indicate connections (2,5,6 & 7) will normally be high and then go low when a connection occurs.</p> <p>Format: ATSSW,4,<PIO Logic></p> <p>Parameters:</p> <ul style="list-style-type: none"> ▪ <i>PIO Logic:</i> <ul style="list-style-type: none"> 0 = (0 = No Connection, +3.3v = Connection) 1 = (+3.3v = No Connection, 0 = Connection) <p>Factory Default: 0</p> <p>EXAMPLE: <i>TYPE : ATSSW,4,1<cr></i> <i>REPLY: <cr_lf>OK<cr_lf></i> OR <i> <cr_lf>ERROR<cr_lf></i></p> <p>Read Using: ATRSW,4</p> <p><i>Note: Requires a reset for change to take affect.</i></p>
RSW,4	<p>READ CONNECTION LOGIC</p> <p>Function: Sets the connection PIO logic register state.</p>

	<p>Format: ATRSW,4</p> <p>Return Parameters: <PIO Logic></p> <p>EXAMPLE: <i>TYPE : ATRSW,4<cr></i> <i>REPLY: <cr_lf>OK<cr_lf></i> <i><cr_lf>00<cr_lf></i></p> <p>Set Using: ATSSW,4</p>
--	--

3.7.10 Transmitting on a Specific Channel Only

<i>SWC</i>	<p>Select Transmission Channel</p> <p>Function: Allows the user to select a single channel to transmit on in multipoint mode. The radio can still receive data from any of the other three channels.</p> <p>Format: ATSWC,<Select>,<Channel></p> <p>Parameters:</p> <ul style="list-style-type: none"> ▪ <i>Select:</i> <ul style="list-style-type: none"> 0 = Deselect the channel as the current transmission channel 1 = Select the channel as the current transmission channel ▪ <i>Channel:</i> 0-3 <p>EXAMPLE: <i>TYPE : ATSWC,1,0<cr></i> <i>REPLY: <cr_lf>OK<cr_lf></i> OR <i><cr_lf>ERROR<cr_lf></i></p> <p>Read Using: ATSI,21</p> <p><i>Note: If the selected channel is disconnected the radio will default to transmitting on all channels.</i></p>
------------	---

3.7.11 Making the Radio Discoverable and Undiscoverable

<i>SDIS</i>	<p>Set Discoverable</p> <p>Function: Makes the radio discoverable and connectable.</p> <p>Format: ATSDIS</p>
-------------	---

	<p>EXAMPLE: <i>TYPE</i> : ATSDIS<cr> <i>REPLY</i>: <cr_lf>OK<cr_lf></p>
UDIS	<p>Set Undiscoverable</p> <p>Function: Makes the radio undiscoverable and unconnectable.</p> <p>Format: ATUDIS</p> <p>EXAMPLE: <i>TYPE</i> : ATSDIS<cr> <i>REPLY</i>: <cr_lf>OK<cr_lf></p>

4 Using FTP and OPP Modes

Using the radio in FTP and OPP modes is much different from any of the other available connection modes. Connections are not made using ATDM or ATDS and services are not configured using the ATSSNC command. Connection status must be obtained using ATSI22, as ATSI3 contains no information regarding FTP or OPP connections. In addition only one connection is allowed at a time, so multi-point mode will be disabled once the radio is in FTP or OPP mode.

To use the radio as an FTP or OPP client simply use the ATDFTP or ATDOPP command to make a connection to a server. In order to use the radio as an FTP or OPP server the user must set the Power-Up Connection Mode parameter in ATSW25 to either 7 or 8. Following a reset the radio will only have one service exposed, which will either be an FTP or OPP server depending on the value set in ATSW25.

Be aware that due to the extra overhead required to operate in FTP and OPP modes, the data throughput in these modes will be much lower. The radio will not operate in Data Mode or Fast Data Mode, so the comm parameter in ATSW25 will have no effect on the throughput. In FTP or OPP client mode the throughput will be approximately 30kbps if the radio is in idle mode prior to making a connection. If the radio is not in idle mode the client throughput will be approximately 15kbps. As an FTP or OPP server the maximum throughput will be approximately 1.4kbps.

4.1 FTP Client

The following FTP (File Transfer Protocol) commands allow the radio to be used as an FTP client, enabling it to manipulate files on an FTP server. As the client, the radio will initiate the connection with the server, e.g. a PC, PDA, or cell phone. After making a connection the radio can browse the server's *Bluetooth* exchange directory, as well as upload and download files to and from the server.

Note: To achieve the maximum data throughput of 30kbps in FTP client mode execute an ATUCL command prior to making an FTP connection to put the radio in idle mode. If the radio is not in idle mode the data throughput will be approximately 15kbps.

4.1.1 FTP Connect/Disconnect

DFTP	<p>DIAL FTP</p> <p>Function: This command creates a connection to the OBEX File Transfer service on a remote radio. Once this command has been sent the radio will be unconnectable until the FTP connection is disconnected.</p> <p>Format: ATDFTP,<BT Address></p> <p>Parameters:</p> <ul style="list-style-type: none"> ▪ <i>BT Address:</i> Bluetooth Address, 12 hex characters MAX <p>Return Parameters: <BT Address></p> <p>EXAMPLE:</p> <pre> TYPE : ATDFTP,123456789012<cr> REPLY: <cr_lf>OK<cr_lf> <cr_lf>FTP CONNECT,123456789012<cr_lf> OR <cr_lf>OK<cr_lf> <cr_lf>PAIRED,123456789012<cr_lf> // if security is enabled </pre>
-------------	--

	<pre><cr_lf>CONNECT,123456789012<cr_lf> OR <cr_lf>FTP NO ANSWER<cr_lf> // if device not present</pre> <p>Notes:</p> <ul style="list-style-type: none"> ▪ If the remote slave device is not present or the service is not available, FTP NO ANSWER will reply after the master connect timeout and you will have to try again. ▪ If security is enabled and the radio is connecting to a laptop that has not yet been paired with it, the <cr_lf>PAIRED,12345678912<cr_lf> message may return twice prior to the FTPC CONNECT. ▪ By default you will be located in the Bluetooth Exchange Folder of the remote device, this will be the root directory. ▪ After making an FTP connection the radio will still be in command mode, not data mode.
DHFTP	<p>DIAL HANG UP FTP</p> <p>Function: This command will disconnect the current FTP connection.</p> <p>Format: ATDHFTP</p> <p>EXAMPLE:</p> <pre>TYPE : ATDHFTP REPLY: <cr_lf>OK<cr_lf> <cr_lf>FTP DISCONNECT<cr_lf> OR <cr_lf>ERROR<cr_lf></pre>

4.1.2 FTP Directory Navigation

FTPB	<p>FTP BROWSE</p> <p>Function: This command returns an XML file displaying the contents of the current FTP directory.</p> <p>Format: ATFTPB</p> <p>Return Parameters: <XML Directory Information></p> <p>EXAMPLE:</p> <pre>TYPE : ATFTPB REPLY: <cr_lf>OK<cr_lf> <?xml version="1.0"?><lf> <!DOCTYPE folder-listing SYSTEM "obex-folder-listing.dtd"><lf> <folder-listing version="1.0"><lf> <folder name="Test Folder" size="0" user-perm="RWD" modified="20060828T203109Z" created="20060828T203018Z"</pre>
------	---

	<pre> accessed="20060828T203110Z"/><lf> <file name="TestFile0.txt" size="1" user-perm="RWD" modified="20060828T203058Z" created="20060828T203040Z" accessed="20060828T203058Z"/><lf> </folder-listing><lf><NULL><NULL> <cr_lf>BROWSE COMPLETE<cr_lf> OR <cr_lf>ERROR<cr_lf> </pre> <p><i>Note: There are two NULL characters at the end of the XML file, after the </folder-listing> element.</i></p>
<p>FTPSUB</p>	<p>MOVE TO FTP SUB-DIRECTORY</p> <p>Function: This command will navigate you to a sub-directory of the current FTP directory.</p> <p>Format: ATFTPSUB,<Directory>,<Create></p> <p>Parameters:</p> <ul style="list-style-type: none"> ▪ Folder Name: Path of destination directory, 64 characters MAX ▪ Create: <ul style="list-style-type: none"> 0 = Do not create new directory if directory does not exist 1 = Create new directory if directory does not exist <p>EXAMPLES:</p> <pre> TYPE : ATFTPSUB,TestFolder,0<cr> REPLY: <cr_lf>OK<cr_lf> OR <cr_lf>ERROR<cr_lf> TYPE : ATFTPSUB,TestFolder/NewFolder,1<cr> REPLY: <cr_lf>OK<cr_lf> OR <cr_lf>ERROR<cr_lf> </pre> <p><i>Note: The maximum file path length supported by Windows is 255, if this length is exceeded using the ATFTPSUB command you will receive an ERROR message.</i></p>
<p>FTPUP</p>	<p>MOVE TO FTP PARENT DIRECTORY</p> <p>Function: This command will navigate you to the parent directory of the current FTP directory.</p> <p>Format: ATFTPUP</p> <p>EXAMPLE:</p> <pre> TYPE : ATFTPUP<cr> REPLY: <cr_lf>OK<cr_lf> OR <cr_lf>ERROR<cr_lf> </pre>

FTPROOT	<p>MOVE TO FTP ROOT DIRECTORY</p> <p>Function: This command will navigate you to the FTP root directory.</p> <p>Format: ATFTPROOT</p> <p>EXAMPLE:</p> <pre>TYPE : ATFTPROOT<cr> REPLY: <cr_lf>OK<cr_lf> OR <cr_lf>ERROR<cr_lf></pre> <p><i>Note:</i> The root directory is the Bluetooth Exchange Folder of the remote device.</p>
----------------	--

4.1.3 FTP Push/Pull

FTPPUSH	<p>FTP PUSH</p> <p>Function: This command transfers a file to the current FTP directory.</p> <p>Format: ATFTPPUSH,<File Name>,<File Extension>,<File Size>,<Trace></p> <p>Parameters:</p> <ul style="list-style-type: none">▪ <i>File Name:</i> 64 characters MAX▪ <i>File Extension:</i> 4 characters MAX (Ex: .txt, .jpg, .html)▪ <i>File Size:</i> Size of file in bytes, 4294967295 MAX▪ <i>Trace:</i><ul style="list-style-type: none">0 = Do not output transfer progress trace1 = Output transfer progress trace <p>Return Parameters: <Bytes Sent></p> <p>EXAMPLE WITHOUT TRACE ENABLED:</p> <pre>TYPE : ATFTPPUSH,Test,txt,100,0<cr> REPLY: <cr_lf>OK<cr_lf></pre> <p>TYPE : <100 Bytes of Data> REPLY: <cr_lf>PUSH COMPLETE<cr_lf> OR <cr_lf>ERROR<cr_lf></p> <p>EXAMPLE WITH TRACE ENABLED:</p> <pre>TYPE : ATFTPPUSH,Test,txt,100,1<cr> REPLY: <cr_lf>OK<cr_lf></pre> <p>TYPE : <100 Bytes of Data> REPLY: <cr_lf>SENT,00000001/00000064<cr_lf> <cr_lf>SENT,00000051/00000064<cr_lf> <cr_lf>PUSH COMPLETE<cr_lf></p>
----------------	---

	<p>OR</p> <p><cr_lf>ERROR<cr_lf></p> <p><i>Notes: If the name of the file matches an existing file in the current FTP directory it will be overwritten without warning.</i></p>
FTPPULL	<p>FTP PULL</p> <p>Function: This command reads a file from the current FTP directory.</p> <p>Format: ATFTPPULL,<File Name>,<File Extension></p> <p>Parameters:</p> <ul style="list-style-type: none">▪ <i>File Name:</i> 64 characters MAX▪ <i>File Extension:</i> 4 characters MAX (Ex: .txt, .jpg, .html) <p>Return Parameters: <File Size>,<File Data></p> <p>EXAMPLE:</p> <p><i>TYPE :</i> ATFTPPULL,Test,txt<cr></p> <p><i>REPLY:</i> <cr_lf>OK<cr_lf> <cr_lf>File,001E,0123456789012345678901234567890123456789<cr_lf> <cr_lf>PULL COMPLETE<cr_lf></p> <p>OR</p> <p><cr_lf>ERROR<cr_lf></p>

4.2 FTP Server

Setting the Connection Mode in ATSW25 to 8 will cause the radio to behave as an FTP Server. As the server the radio will not initiate any connections, but will accept one connection at a time from a client. The FTP server functionality of the module is limited: the client can push files to the radio, but cannot browse for or download files.

4.2.1 FTP Server Push Example Using Broadcomm Stack

Enable FTP Server Mode:

Sent: ATSW25,8,1,0,0<cr>
Reply: <cr_lf>OK<cr_lf>
Sent: ATURST<cr>

On a PC open "Bluetooth Places" and search for devices. After the device is found double click it and verify its service to be "OBEX FTP on <Friendly Name>". Copy the file, then go back to the Bluetooth places window and paste the file on the FTP Service Icon. The PC will then make a connection to the radio, push the data, and then disconnect.

Reply: <cr_lf> FTP CONNECT,123456789012<cr_lf>
<cr_lf>PUSH START,New Text File.txt,00000039<cr_lf> //Length is in HEX
This is a test file for FTP server. <cr_lf>
Have a nice day. <cr_lf>

<cr_lf>PUSH COMPLETE<cr_lf>
<cr_lf>FTP DISCONNECT<cr_lf>

4.3 OPP Client Commands

The following OPP (Object Push Profile) commands allow the radio to be used as an OPP client, enabling it to manipulate files on an OPP server. As the client, the radio will initiate the connection with the server, e.g. a PC, PDA, or cell phone. After making a connection the radio can push and pull objects.

Note: To achieve the maximum data throughput of 30kbps in OPP client mode execute an ATUCL command prior to making an OPP connection to put the radio in idle mode. If the radio is not in idle mode the data throughput will be approximately 15kbps.

4.3.1 OPP Connect/Disconnect

DOPP	<p>DIAL OPP</p> <p>Function: This command creates a connection to the OPP service on a remote radio. Once this command has been sent the radio will be unconnectable until the OPP connection is disconnected.</p> <p>Format: ATDOPP,<BT Address></p> <p>Parameters:</p> <ul style="list-style-type: none">▪ <i>BT Address: Bluetooth Address, 12 hex characters MAX</i> <p>Return Parameters: <BT Address></p> <p>EXAMPLE:</p> <pre>TYPE : ATDOPP,123456789012<cr> REPLY: <cr_lf>OK<cr_lf> <cr_lf>OPP CONNECT,123456789012<cr_lf> OR <cr_lf>OK<cr_lf> <cr_lf>PAIRED,123456789012<cr_lf> // if security is enabled <cr_lf>OPP CONNECT,123456789012<cr_lf> OR <cr_lf>OK<cr_lf> <cr_lf>OPP NO ANSWER<cr_lf> // if device not present</pre> <p>Notes:</p> <ul style="list-style-type: none">▪ <i>If the remote slave device is not present or the service is not available, OPP NO ANSWER will reply after the master connect timeout and you will have to try again.</i>▪ <i>If security is enabled and the radio is connecting to a laptop that has not yet been paired with it, the <cr_lf>PAIRED,12345678912<cr_lf> message may return twice prior to the OPP CONNECT.</i>▪ <i>By default you will be located in the Bluetooth Exchange Folder of the remote device, this will be the root directory.</i>
-------------	--

	<ul style="list-style-type: none"> After making an OPP connection the radio will still be in command mode, not data mode.
DHOPP	<p>DIAL HANG UP OPP</p> <p>Function: This command will disconnect the current OPP connection.</p> <p>Format: ATDHOPP</p> <p>EXAMPLE:</p> <p>TYPE : ATDHOPP REPLY: <cr_lf>OK<cr_lf> <cr_lf>OPP DISCONNECT<cr_lf> OR <cr_lf>ERROR<cr_lf></p>

4.3.2 OPP Push/Pull

SBCARD	<p>BUSINESS CARD PUSH</p> <p>Function: This command transfers a business card file to the OPP server.</p> <p>Format: ATSBCARD,<File Name>,<File Extension>,<File Size></p> <p>Parameters:</p> <ul style="list-style-type: none"> File Name: 64 characters MAX File Extension: 3 characters MAX (Ex: .rtf .vcf) File Size: Size of file in bytes, 65535 MAX <p>EXAMPLE:</p> <p>TYPE : ATSBCARD,Test,txt,100<cr> REPLY: <cr_lf>OK<cr_lf></p> <p>TYPE : <100 Bytes of Business Card Data> REPLY: <cr_lf>PUSH COMPLETE<cr_lf> OR <cr_lf>ERROR<cr_lf></p> <p><i>Note: Most devices such as PC's and phones will rename the business card file to <Contact's Full Name>.<File Extension> once it has been received.</i></p>
RBCARD	<p>BUSINESS CARD PULL</p> <p>Function: This command reads a business card file from the OPP server.</p> <p>Format: ATRBCARD</p> <p>Return Parameters: <VCARD Data></p>

	<p>EXAMPLE:</p> <pre> TYPE : ATRBCARD<cr> REPLY: <cr_lf>OK<cr_lf> John Smith.vcf,00E3<cr_lf> BEGIN:VCARD<cr_lf> VERSION:2.1<cr_lf> N:Smith;John<cr_lf> FN:John Smith<cr_lf> ADR;HOME;;;box ;city;CO;00000;United States of Ame<cr_lf> TEL;WORK;VOICE:5551234567<cr_lf> EMAIL;INTERNET;PREF:johnsmith@domain.com<cr_lf> X-IRMC-LUID:02000000<cr_lf> END:VCARD<cr_lf> <cr_lf>PULL COMPLETE<cr_lf> OR <cr_lf>ERROR<cr_lf> </pre>
<p>OPPPUSH</p>	<p>OBJECT PUSH</p> <p>Function: This command pushes an object to the OPP server.</p> <p>Format: ATOPPPUSH,<File Name>,<File Extension>,<Type>,<File Size></p> <p>Parameters:</p> <ul style="list-style-type: none"> ▪ <i>File Name:</i> 64 characters MAX ▪ <i>File Extension:</i> 3 characters MAX (Ex: .rtf .vcf) ▪ <i>Type:</i> 64 characters MAX ▪ <i>File Size:</i> Size of file in bytes, 65535 MAX <p>EXAMPLE:</p> <pre> TYPE : ATPIMPUSH,file,vcs,text/x-vcalendar,453<cr> REPLY: <cr_lf>OK<cr_lf> TYPE : <100 Bytes of Data> REPLY: <cr_lf>PUSH COMPLETE<cr_lf> OR <cr_lf>ERROR<cr_lf> </pre>

4.4 OPP Server

Setting the Connection Mode in ATSW25 to 7 will cause the radio to behave as an OPP Server. As the server the radio will not initiate any connections, but will accept one connection at a time from a client. The OPP server functionality of the module is limited: a client can push all objects to the server, but only business cards can be pulled.

4.4.1 Handling OPP Server Business Card Requests

<p>BCARDR</p>	<p>HANDLE BUSINESS CARD REQUEST</p> <p>Function: This command transfers a business card file to an OPP client that</p>
----------------------	--

has requested a business card. This command can only be used after receiving a PULL REQUEST from the client.

Format: ATBCARDR,<File Name>,<File Extension>,<File Size>

Parameters:

- *File Name:* 64 characters MAX
- *File Extension:* 3 characters MAX (Ex: .rtf .vcf)
- *File Size:* Size of file in bytes, 65535 MAX

EXAMPLE:

```
REPLY: <cr_lf>OPP CONNECT,123456789012<cr_lf>
<cr_lf>PULL REQUEST<cr_lf>
TYPE : ATBCARDR,John Smith,vcf,227<cr>
<100 Bytes of Business Card Data>
REPLY: <cr_lf>PULL COMPLETE<cr_lf>
<cr_lf>OPP DISCONNECT<cr_lf>
OR
<cr_lf>ERROR<cr_lf>
```

Note: Most devices such as PC's and phones will rename the business card file to <Contact's Full Name>.<File Extension> once it has been received.

4.4.2 OPP Server Send Business Card using Broadcom Stack

Enable OPP Server Mode:

Sent: ATSW25,7,1,0,0<cr>

Reply: <cr_lf>OK<cr_lf>

Sent: ATURST<cr>

On a PC open "Bluetooth Places" and search for devices. After the device is found double click it and verify its service to be "OBEX Object Push on <Friendly Name>". Right click the icon and select Send Business Card. When prompted select the vCard file you would like to send. The PC will connect to the server and push the business card, disconnecting when complete.

```
Reply: <cr_lf> OPP CONNECT,123456789012<cr_lf>
<cr_lf>PUSH START,John Smith.vcf,00E3<cr_lf> //Length is in HEX
BEGIN:VCARD<cr_lf>
VERSION:2.1<cr_lf>
N:Smith;John<cr_lf>
FN:John Smith<cr_lf>
ADR:HOME::;box ;city;CO;00000;United States of Ame<cr_lf>
TEL;WORK;VOICE:5551234567<cr_lf>
EMAIL;INTERNET;PREF:johnsmith@domain.com<cr_lf>
X-IRMC-LUID:02000000<cr_lf>
END:VCARD<cr_lf>
<cr_lf>PUSH COMPLETE<cr_lf>
<cr_lf>OPP DISCONNECT<cr_lf>
```

4.4.3 OPP Server Receive Business Card using Broadcom Stack

Enable OPP Server Mode:

Sent: ATSW25,7,1,0,0<cr>
Reply: <cr_lf>OK<cr_lf>
Sent: ATURST<cr>

On a PC open "Bluetooth Places" and search for devices. After the device is found double click it and verify it's service to be "OBEX Object Push on <Friendly Name>". Right click the icon and select Receive Business Card. The PC will make a connection to the server, and the radio will output "PULL REQUEST." Then use the ATBCARDR command to send a business card to the PC.

Reply: <cr_lf> OPP CONNECT,123456789012<cr_lf>
<cr_lf>PULL REQUEST<cr_lf>
Sent: <cr_lf>ATBCARDR, John Smith,vcf,227<cr_lf>
<227 Bytes of vCard Data>
Reply:<cr_lf>PULL COMPLETE<cr_lf>
<cr_lf>OPP DISCONNECT<cr_lf>

4.4.4 OPP Server Send Data using TransSend

Enable OPP Server mode and set the COD of the device to a known COD, such as that of a laptop so that TransSend will discover the radio.

Sent: ATSW25,7,1,0,0<cr>
Reply: <cr_lf>OK<cr_lf>
Sent: ATSC,0072010c<cr> // TransSend uses COD filtering, so use a known COD.
Reply: <cr_lf>OK<cr_lf>
Sent: ATURST<cr>

Open your browser and find the picture or block of text you would like to send. After you have done this highlight all you wish to send then right click it and go to "TransSend to device with Bluetooth" and click note or picture. Wait for TransSend to search for devices and select the desired device. If sending text select "Plain Text," to send the data click OK.

Reply: <cr_lf> OPP CONNECT,123456789012<cr_lf>
<cr_lf>PUSH START,John Smith.vcf,0015<cr_lf> //Length is in HEX
This is a test note.<cr_lf>
<cr_lf>PUSH COMPLETE<cr_lf>
<cr_lf>OPP DISCONNECT<cr_lf>

5 BlueRadios Factory Default Settings

Note: Apply 3.3Vdc on PIO(4) for >2 sec. during initial power up will revert all user definable settings to the factory defaults shown below. The other option is to use the software command **ATFRST**. The only exception for these two options is the name of device (friendly name) the **BlueRadios** and PIN will not change back if you had changed this already. Allow approximately 5 seconds for the radio to reconfigure. On the **BlueRadios** evaluation boards we included a push button for PIO(4) factory reset which can be held down for 1 second while power is applied to the radio.

- Bypass Hardware Factory Reset = Enabled
- Escape Character = '+'
- Max Connection Number = 1
- Radio Name = "BlueRadios"
- Country Code = North America and Europe
- Module Type = BlueRadios ATMP
- Boot Mode = Virtual Machine (VM) Mode
- Service Name = "COM0" (Ch0), "COM1" (Ch1), "COM2" (Ch2), "COM3" (Ch3)
- PIN = "default"
- COD = 00000000
- UART Setting = 9600 Baud, 8 Data Bits, No Parity, 1 Stop Bit (8,N,1)
- Hardware flow control RTS/CTS = Enabled
- Page Scan Interval = 1024 (640ms)
- Page Scan Window = 512 (320ms)
- Inquiry Scan Interval = 1024 (640ms)
- Inquiry Scan Window = 512 (320ms)
- PIO Directions (Point to Point) = 6-In, 7-In
- PIO Directions (Multipoint) = 6-Out, 7-Out
- Response Type = Long Response
- Security = Disabled (If the security flag is enabled a factory reset of parameters does not disable security)
- Security Level = Link Level, if security flag is enabled services are provided only with PIN exchange.
- Automatic SCO Connect = Disabled
- Minor Filter = Disabled
- Default Boot Mode = Slave
- Radio Status = 1,0 (Slave Disconnected)
- Default Comm Mode = Data
- Unconnected UART Mode = Allow Data to Pass While Unconnected
- *Bluetooth* Service Profile = Serial Port Profile (SPP)
- Lock User Settings = Disabled
- PIO(5) LED Rate = 1000ms
- Inquiry Timeout = 16s
- Master Connect Request Timeout = 40s
- PIN Lock Mode = ATOP Disable
- Deep Sleep Mode = Never Go Into Deep Sleep
- Pairing Timeout = 30 seconds
- Class1 Radio Max Transmit Power = 15dbm. Class2 module will still have a max of 4dbm output performance even though you can set it to 15.
- Link Supervisory Timeout = ~4s

Miscellaneous Items:

- Over the air RF guaranteed data packet retries is set for indefinite.

6 **BlueRadios Class1 Module Power Consumptions**

Idle Mode \approx 1.4mA average

Deep Sleep Mode \approx 25-50uA (Idle Mode)

- If in Sniff Mode, will go momentarily as low as 50uA in between processes.

Slave Unconnected \approx 39mA average

- ATSW21,4096,18,4096,18 settings will result in the Slave not connected \approx 1mA average.
- ATSW21,4096,18,4096,18 settings along with enabling Deep Sleep Mode will result in an unconnected slave current draw of \approx 350uA average.

Master Unconnected \approx 1.4mA average

- A Master radio not in use it is better to just turn off the power completely to the radio and draw zero current.

Master Inquiry \approx 60mA average

- For the first couple of seconds before it connects to the Slave

Connected \approx 5mA average

- ATSNIFF,1600,160,10,160 will result in the Slave connected \approx 1.4mA average, with no data being sent.
- This can even go as low as 0.6mA if you make the Slave not discoverable but connectable.

If you perform a remote *Bluetooth* RF "ATDH" disconnect command from any Master to the BlueRadios Slave radio, the Slave radio will go into idle mode. You will have to either send a command to the Slave radio through its local UART or cycle power on the radios to have it come back up in Slave mode. This was designed as if you were communicating to the local UART on the Slave radio. Typically a Slave never sends a commanded disconnect only the Master does. In this mode you can devise some clever power saving features like leaving the Slave in idle mode until another event triggers the radio to go back into Slave discoverable mode. It is important to remember a device in Idle Mode is not discoverable which has some security advantages. The same sort of benefits can be achieved by just controlling when the radio is turned off/on again.

7 Example Connection Sequences

7.1 Master Discovery/Connection Sequence

From power up and no connection:

- 1) Perform an Inquiry to obtain **BT Address's** (unless it is already known).

Sent : ATUCL<cr> // Clears radio state and places in Idle Mode

Reply:<cr_if>OK<cr_if>

Sent : ATDI,1,00000000 {Class of Device}<cr> // Looks for only one Bluetooth device

Reply:<cr_if>00A0961F2023,00000104,BLUERADIOS<cr_if>
<cr_if>DONE<cr_if>

- 2) Perform a Master Connect over SPP using the **BT Address**.

Sent : ATDM, 00A0961F2023,1101<cr> // SPP connection

Reply:<cr_if>CONNECT,00A0961F008F <cr_if> // Returns Slave BT address radios is in Data Mode

- 3) Place radio into Fast Data Mode.

Sent : ATMF<cr> // Places radio in Fast Data Mode

Reply:<cr_if>OK<cr_if>

- 4) Send Data.

Note: When sending commands from the Slave when the Slave connects in Fast Data Mode (ATSW25/or issuing ATMF). All valid AT commands are sent through the Slaves UART will be interpreted and responded by the Master radio as if it was the local Slave radio. Basically in this configuration from the Slave end you can obtain status and configure from the remote Master radio. This is a unique feature that may be useful in some applications but can confuse the user if you think you are talking to the local Slave UART.

To get out of Data Mode and check status:

- 1) Delay at least 50 milliseconds; this could be less or more.

- 2) Get into Command Mode.

Sent : +++<cr> // Default escape sequence of characters

Reply:<cr_if>OK<cr_if>

- 3) Check Status

Sent : AT<cr>

Reply:<cr_if>OK<cr_if>

- 4) Or send any AT Command example:

Sent : ATSI,0<cr>

Reply:<cr_if>BlueRadios AT<cr_if>

7.2 Slave Command Sequence

From power up:

- 1) Perform an inquiry and search for Slave Bluetooth device with a PC or other embedded unit.
- 2) Send a connection request from PC or embedded device to the Slave.
- 3) Wait for a connection
Reply:`<cr_lf>CONNECT,{SLAVE ADDRESS}<cr_lf>` // SPP Connected
- 4) Send Data.

Note: This command sequence assumes the radio is in factory default in which it automatically comes up and is connectable as a Slave from a Master request.

To get out of Data Mode and check status:

- 1) Delay at least 50 milliseconds; this could be less or more.
- 2) Check Status, perform a Disconnect ...etc.

Sent : `AT<cr>`
Reply: `<cr_lf>OK<cr_lf>`

7.3 Audio and Data Connection (From Master to Remote Slave)

Master Radio:

Sent : `ATSW25,1,1,0,0<cr>` // Set ConnectMode Master & data mode
Reply: `<cr_lf>OK<cr_lf>`
Perform hardware or software reset for the above changes to take effect on Master radio
Sent : `ATDM,{SLAVE ADDRESS},1101<cr>` // Serial Port Profile
Reply: `<cr_lf>OK<cr_lf>`
Reply: `<cr_lf>CONNECT,{SLAVE ADDRESS}<cr_lf>` // SPP Connected
"You can now send data back and fourth between the two units"
Sent : `+++<cr>` // Default escape sequence of characters
Reply: `<cr_lf>OK<cr_lf>`
Sent : `ATDSCO<cr_lf>` // Dial Audio SCO
Reply: `<cr_lf>SCO CONNECT<cr_lf>` // Audio channel connected
Sent : `+++<cr>`
Reply: `<cr_lf>OK<cr_lf>`
Sent : `ATMD<cr>` // Place back into Data mode
Reply: `<cr_lf>OK<cr_lf>`
"You can now send data over SPP and simultaneously talk over the SCO audio channel"
Sent : `ATDH<cr>` // Hang up Audio SCO & SPP
Reply: `<cr_lf>OK<cr_lf>`
Reply: `<cr_lf>DISCONNECT<cr_lf>` // SPP disconnected
Reply: `<cr_lf>SCO DISCONNECT<cr_lf>` // audio channel disconnected

Note: Using `ATDHSCO` will disconnect audio channel but you will need to type `ATMD` to go back into data mode to send characters.

8 Example Server Applications

8.1 Headset Point-to-Point

Sent: ATSW25,0,1,0,0<cr> // Sets connect mode to slave
Reply: <cr_lf>OK<cr_lf>
Sent: ATSSNC,0,Headset0,1108<cr> // Sets service and name
Reply: <cr_lf>OK<cr_lf>
Sent: ATSC,00200404<cr> // Sets COD to a known headset COD
Reply: <cr_lf>OK<cr_lf>

8.2 Headset Multipoint

Sent: ATSSW,3,4<cr > // Sets connection number to 4
Reply: <cr_lf>OK<cr_lf>
Sent: ATSSNC,0,Headset0,1108<cr > // Sets service and name
Reply: <cr_lf>OK<cr_lf>
Sent: ATSC,00200404<cr> // Sets COD to a known headset COD
Reply: <cr_lf>OK<cr_lf>

8.3 Audio Gateway Point-to-Point

Sent: ATSSNC,0,gateway0,1112<cr> // Sets service and name
Reply: <cr_lf>OK<cr_lf>
Sent: ATSW25,0,1,0,0<cr> // Sets connect mode to slave
Reply: <cr_lf>OK<cr_lf>
Sent: ATSC,00200404<cr> // Sets COD to a known headset COD
Reply: <cr_lf>OK<cr_lf>

8.4 Audio Gateway Multipoint

Sent: ATSSW,3,4<cr > // Sets connection number to 4
Reply: <cr_lf>OK<cr_lf>
Sent: ATSSNC,0,gateway0,1112<cr> // Sets service and name
Reply: <cr_lf>OK<cr_lf>
Sent: ATSC,00200404<cr> // Sets COD to a known headset COD
Reply: <cr_lf>OK<cr_lf>

8.5 DUN Point-to-Point

Sent: ATSSNC,0,dun0,1103<cr> // Sets service and name
Reply: <cr_lf>OK<cr_lf>
Sent: ATSW25,0,1,0,0<cr> // Sets connect mode to Slave
Reply: <cr_lf>OK<cr_lf>
Sent: ATSC,00420210<cr> // Sets COD to a known DUN COD
Reply: <cr_lf>OK<cr_lf>

8.6 DUN Multipoint

Sent: ATSSW,3,4<cr> // Sets connection number to 4
Reply: <cr_lf>OK<cr_lf>
Sent: ATSSNC,0,dun0,1103<cr> // Sets service and name

Reply: <cr_lf>OK<cr_lf>
Sent: ATSC,00420210<cr>
Reply: <cr_lf>OK<cr_lf>

// Sets COD to a known DUN COD

8.7 LAN Point-to-Point

Sent: ATSSNC,0,lan0,1102<cr>
Reply: <cr_lf>OK<cr_lf>
Sent: ATSW25,0,1,0,0<cr>
Reply: <cr_lf>OK<cr_lf>
Sent: ATSC,00020300<cr>
Reply: <cr_lf>OK<cr_lf>

// Sets service and name

// Sets connect mode to slave

// Sets COD to a known LAN COD

8.8 LAN Multipoint

Sent: ATSSW,3,4<cr >
Reply: <cr_lf>OK<cr_lf>
Sent: ATSSNC,0,lan0,1102<cr>
Reply: <cr_lf>OK<cr_lf>
Sent: ATSC,00020300<cr>
Reply: <cr_lf>OK<cr_lf>

// Sets connection number to 4

// Sets service and name

// Sets COD to a known LAN COD

9 Example Client Applications

9.1 Audio Gateway

Only supports the connection.

Sent: ATSW24,0,0,1,0<cr>
Reply: <cr_lf>OK<cr_lf>
Sent: ATSC,00200404<cr>
Reply: <cr_lf>OK<cr_lf>
Sent: ATDM,<Headset Address>,1112<cr>
Reply: <cr_lf>OK<cr_lf>

// Sets Auto SCO

// Sets COD to a known headset COD

9.2 DUN

Only supports the connection.

Sent: ATSC,00420210<cr>
Reply: <cr_lf>OK<cr_lf>
Sent: ATDM, <DUN Address>,1103<cr>
Reply: <cr_lf>OK<cr_lf>

// Sets COD to a known DUN COD

// Sets auto connect address

10 Acronyms/Abbreviations

API - Application Protocol Interface
AT – Attention
ATMP – Attention Multi Point
ASCII - American Standard Code for Information Interchange
BCSP - Blue Core Serial Port
BNEP - Bluetooth Networking Encapsulation Protocol
BR - BlueRadios
BT - Bluetooth
BTW - Bluetooth Windows Stack
COD - Class Of Device
COM - Communications
CR - Carriage Return
CTS - Clear To Send
DSR - Data Sent Receive
GND - Ground
HCI - Host Controller Interface
IP – Internet Protocol
LF - Line Feed
MCU - Microcontroller Unit
MISO - Master In Slave Out
MOSI – Master Out Slave In
NC - Not Connected
PC - Personal Computer
PCB - Printed Circuit Board
PCM - Pulse Code Modulation
PAN - Personnel Area Networking
PIN - Personal Identification Number
RF - Radio Frequency
PIO - Pin Input/Output
RST - Reset
RTS - Ready To Send
RX - Receive
SCO - Synchronous Connection-Oriented: the links used by BT to send audio.
SMT - Surface Mount Technology
SPI - Serial Protocol Interface
SPICK - SPI Clock
SPICS - SPI Chip Select
TTL - Transistor Transistor Logic
TX - Transmit
UART - Universal Asynchronous Receiver/Transmitter
USB - Universal Serial Bus
UUID - Universal Unique Identifier – maintain by Bluetooth SIG.
VCC - DC Power
VDD - DC Power
VM – Virtual Machine

Go to www.blueradios.com and look on the left hand column to download *Bluetooth* Glossary of Terms PDF and other materials.

APPENDIX A: AT Command Summary Table

AT Command	Description	Requires Reset	Stores Permanently
Attention Prefix			
AT	Attention Prefix	N/A	N/A
Firmware Version			
ATVER,ver1	Module Firmware Version	N/A	Yes
Resetting			
ATURST	Unit Reset	N/A	N/A
ATFRST	Factory Reset	N/A	N/A
ATSSW,0	Set Bypass PIO(4) Factory Reconfiguration	Yes	Yes
ATRSW,0	Read Bypass PIO(4) Factory Reconfiguration	N/A	Yes
Boot Mode			
ATSSW,1	Set Boot Mode	Yes	Yes
ATRSW,1	Get Boot Mode	N/A	N/A
Security Level			
ATSSW,2	Set Security Level	Yes	Yes
ATRSW,2	Get Security Level	N/A	N/A
Get Status			
ATSI,0	Get Module Type	N/A	Yes
ATSI,1	Get Bluetooth Address	N/A	Yes
ATSI,2	Get Friendly Name	N/A	Yes
ATSI,3	Get Current Status of Connections	N/A	Yes
ATSI,4	Get Service Name	N/A	Yes
ATSI,5	Get Class of Device (COD)	N/A	Yes
ATSI,6	Get Response, Security, Auto SCO, Filter Settings	N/A	Yes
ATSI,7	Get Connection, Comm, UART, Service Modes	N/A	Yes
ATSI,8	Get UART Settings	N/A	Yes
ATSI,9	Get Master Auto-Connect Address	N/A	Yes
ATSI,10	Get Slave Scan Intervals and Windows	N/A	Yes
ATSI,11	Get PIO(5) Pulse Rate	N/A	Yes
ATSI,12	Get Escape Character	N/A	Yes
ATSI,13	Get Timeout Settings	N/A	Yes
ATSI,14	Get Maximum TX Power Level	N/A	Yes
ATSI,15	Get PIN Lock Mode	N/A	Yes
ATSI,16	Get Deep Sleep Mode	N/A	Yes
ATSI,17	Get Sniff Settings	N/A	Yes
ATSI,18	Get Link Supervisory Timeout	N/A	Yes
ATSI,19	Get List of Paired or Secured Addresses	N/A	Yes
ATSI,20	Get Channel UUIDs	N/A	Yes
ATSI,21	Get Specific Transmission Channel	N/A	Yes
ATSI,22	Get FTP/OPP Connection Status	N/A	Yes
# of Connections			

BR-AT_COMMANDS-100 Rev. 3.5.2.1.4.0

ATSSW,3	Set Max Connection Number	Yes	Yes
ATRSW,3	Read Max Connection Number	N/A	Yes
Radio Name			
ATSN	Set Radio Name	No	Yes
ATRRN	Read Remote Radio Name By BT Address	N/A	Yes
Service Name			
ATSSN	Set Service Name	Yes	Yes
ATSSNC	Set Service Name by Channel	Yes	Yes
ATRSN	Read Service Name	N/A	Yes
ATRSNC	Read Service Name by Channel	N/A	Yes
ATRRSN	Read Remote Service Name	N/A	Yes
Security PIN			
SSW,6	Set PIN Request Handling Mode	Yes	Yes
RSW,6	Read PIN Request Handling Mode	N/A	Yes
ATSP	Set PIN	No	Yes
ATOP	Overwrite PIN	No	Yes
ATPR	Respond to Manual PIN Request	N/A	No
COD			
ATSC	Set Class of Device (COD)	Yes	Yes
Write Memory			
ATSW,20	Switch 20: Write UART Settings	No	Optional
ATSW,21	Switch 21: Write Slave Scan Intervals & Windows	Yes	Yes
ATSW,22	Switch 22: Write PIO Direction	No	Optional
ATSW,23	Switch 23: Write PIO Level	No	Optional
ATSW,24	Switch 24: Write Default Settings	For Security	Yes
ATSW,25	Switch 25: Write Power Up Default Modes	Yes	Yes
ATSW,26	Switch 26: Lock User Settings	No	Yes
ATSW,27	Switch 27: Write LED Rate	No	Yes
ATSW,28	Switch 28: Write Inquiry Timeout Settings	No	Yes
ATSW,29	Switch 29: Write PIN Lock Mode	No	Yes
ATSW,30	Switch 30: Write Deep Sleep Mode	No	Yes
Read Memory			
ATSR21	Read PIO Level	N/A	N/A
Inquiry			
ATDI	Dial Inquiry	N/A	N/A
ATIL	Last Inquiry	N/A	Yes
Master Connect			
ATDM	Dial As Master	N/A	N/A
ATDC	Dial Channel	N/A	N/A
ATDL	Dial Last	N/A	Yes
ATLAST	Read Last Connected Address	N/A	Yes

Master Default			
ATSMA	Set Master Default Address	Yes	Yes
ATMACLR	Master Address Clear	No	Yes
Connect Slave			
ATDS	Dial As Slave	N/A	N/A
Disconnect			
ATDH	Dial Hang Up	N/A	N/A
ATDHC	Dial Hang Up By Channel	N/A	N/A
Modes			
+++	Default Escape Character	N/A	N/A
ATSESC	Set Command Mode Escape Character	No	Yes
ATMD	Put Radio Into Data Mode	No	No
ATMF	Put Radio Into Fast Data Mode	No	No
Cancel			
ATUCL	Cancel (Idle Mode)	No	No
Pairing			
ATPAIR	Pair Radios	No	Yes
ATUPAIR	Unpair By Index	No	Yes
ATUPAIRB	Unpair By Bluetooth Address	No	Yes
ATCPAIR	Clear all paired or secured connections	No	Yes
Sniff and Park			
ATSNIFF	Enable Sniff	No	Yes
ATSSNIFF	Enable Auto Sniff	No	Yes
ATCSNIFF	Clear Sniff	No	Yes
ATXSNIFF	Exit Sniff	No	N/A
ATPARK	Park	No	No
ATXPARK	Exit Park	No	N/A
RSSI and Link			
ATRSSI	Get RSSI Value	N/A	No
ATRSSIC	Get RSSI Value by Channel	N/A	No
ATLQ	Get Link Quality	N/A	No
ATLQC	Get Link Quality by Channel	N/A	No
Audio PCM			
ATDSCO	Dial SCO	N/A	N/A
ATDHSCO	Dial Hang Up SCO	N/A	N/A
Max TX Power			
ATSPF	Set Max TX Power Level	No	Yes
Link Timeout			
ATLSTO	Link Supervisory Timeout	No	Yes
Variable Storage			

BR-AT_COMMANDS-100 Rev. 3.5.2.1.4.0

ATSTORE	Store Variable	No	Yes
ATREAD	Read Variable	N/A	Yes
Conn PIO Logic			
ATSSW,4	Set Connection PIO Logic	No	Yes
Transmission Ch			
ATSWC	Select Transmission Channel	No	No
Discoverability			
ATSDIS	Set Discoverable	No	No
ATUDIS	Set Undiscoverable	No	No
FTP Client			
ATDFTP	Dial FTP	No	No
ATDHFT	Dial Hang Up FTP	No	No
ATFTPB	FTP Browse	No	No
ATFTPSUB	Move to FTP Sub-Directory	No	No
ATFTPUP	Move to FTP Parent Directory	No	No
ATFTPROOT	Move to Root Directory	No	No
ATFTPPUSH	FTP Push	No	No
ATFTPPULL	FTP Pull	No	No
OPP Client			
ATDOPP	Dial OPP	No	No
ATDHOPP	Dial Hang Up OPP	No	No
ATWBCARD	Push Business Card	No	No
ATRBCARD	Pull Business Card	No	No
ATOPPUSH	Move	No	No
OPP Server			
ATBCARDR	Handle Business Card Request	No	No

Appendix B: Verbalization Responses

Notes on Short Response Mode Structure:

- The first number (2-3 digits) returned identifies the command that was sent. All identifiers are unique to each specific command except for commands such as ATSSN and ATSSNC. These have the same basic function, only ATSSN is for point to point and ATSSNC is for multipoint use. In this case the identifiers will be the same.
- The second number (2 digits) returned after the comma is the response code. If the response code is 00 ("OK" in long response mode) then the command has been successfully received by the radio. This does not mean the command is complete, but just that it has been accepted by the radio, as some commands may not go into effect or return data immediately. Anything other than a 00 returned in the second position means there was an error with the command.
- Any data returned after the second number will vary based on the command entered, see the response table below for data formatting.

Response Table:

All example responses shown are with factory default settings in place. See AT Commands section for description of returned parameters.

AT Command	Example Long Response	Example Short Response
Attention Prefix		
AT	<cr_lf>OK<cr_lf>	<cr_lf>107,00<cr_lf>
Firmware Version		
ATVER,ver1	<cr_lf>OK<cr_lf><cr_lf>Ver 3.5.2.1.4.0<cr_lf>	<cr_lf>52,00,Ver 3.5.2.1.4.0<cr_lf>
Resetting		
ATURST	No Response	No Response
ATFRST	<cr_lf>OK<cr_lf><cr_lf>RESET COMPLETE<cr_lf>	<cr_lf>75,00<cr_lf><cr_lf>RESET COMPLETE<cr_lf>
	<cr_lf>ERROR<cr_lf>	<cr_lf>75,01<cr_lf>
ATSSW,0	<cr_lf>OK<cr_lf>	<cr_lf>102,00<cr_lf>
	<cr_lf>ERROR<cr_lf>	<cr_lf>102,01<cr_lf>
ATRSW,0	<cr_lf>OK<cr_lf><cr_lf>0<cr_lf>	<cr_lf>103,00,00<cr_lf>
Boot Mode		
ATSSW,1	<cr_lf>OK<cr_lf>	<cr_lf>102,00<cr_lf>
	<cr_lf>ERROR<cr_lf>	<cr_lf>102,01<cr_lf>
ATRSW,1	<cr_lf>OK<cr_lf>	<cr_lf>103,00,00<cr_lf>
Security Level		
ATSSW,2	<cr_lf>OK<cr_lf>	<cr_lf>102,00<cr_lf>
	<cr_lf>ERROR<cr_lf>	<cr_lf>102,01<cr_lf>
ATRSW,2	<cr_lf>OK<cr_lf>	<cr_lf>103,00,00<cr_lf>

Get Status		
ATSI,0	<cr_lf>OK<cr_lf><cr_lf>BlueRadios ATMP<cr_lf>	<cr_lf>16,00,BlueRadios ATMP<cr_lf>
ATSI,1	<cr_lf>OK<cr_lf><cr_lf>00A09608F513<cr_lf>	<cr_lf>14,00,123456789012<cr_lf>
ATSI,2	<cr_lf>OK<cr_lf><cr_lf>BlueRadios<cr_lf>	<cr_lf>53,00,0A,BlueRadios<cr_lf>
ATSI,3	<cr_lf>OK<cr_lf><cr_lf>0,0<cr_lf>	<cr_lf>17,00,0,0<cr_lf>
ATSI,4	<cr_lf>OK<cr_lf><cr_lf>COM0<cr_lf>	<cr_lf>18,00,COM0<cr_lf>
ATSI,5	<cr_lf>OK<cr_lf><cr_lf>00000000<cr_lf>	<cr_lf>19,00,00000000<cr_lf>
ATSI,6	<cr_lf>OK<cr_lf><cr_lf>0,0,0,0<cr_lf>	<cr_lf>20,00,1,0,0,0<cr_lf>
ATSI,7	<cr_lf>OK<cr_lf><cr_lf>0,1,0,0<cr_lf>	<cr_lf>21,00,0,1,0,0<cr_lf>
ATSI,8	<cr_lf>OK<cr_lf><cr_lf>0027,0000,0000<cr_lf>	<cr_lf>22,00,0027,0000,0000<cr_lf>
ATSI,9	<cr_lf>OK<cr_lf><cr_lf>Not Set!<cr_lf>	<cr_lf>23,00,Not Set!<cr_lf>
ATSI,10	<cr_lf>OK<cr_lf><cr_lf>0400,0200,0400,0200< cr_lf>	<cr_lf>24,00,0400,0200,0400,0200<cr_lf>
ATSI,11	<cr_lf>OK<cr_lf><cr_lf>03E8<cr_lf>	<cr_lf>25,00,03E8<cr_lf>
ATSI,12	<cr_lf>OK<cr_lf><cr_lf>2B<cr_lf>	<cr_lf>68,00,2B<cr_lf>
ATSI,13	<cr_lf>OK<cr_lf><cr_lf>0010,0028<cr_lf>	<cr_lf>69,00,0010,0028<cr_lf>
ATSI,14	<cr_lf>OK<cr_lf><cr_lf>default<cr_lf>	<cr_lf>71,01<cr_lf>
ATSI,15	<cr_lf>OK<cr_lf><cr_lf>00<cr_lf>	<cr_lf>73,00,00<cr_lf>
ATSI,16	<cr_lf>OK<cr_lf><cr_lf>00<cr_lf>	<cr_lf>76,00,00<cr_lf>
ATSI,17	<cr_lf>OK<cr_lf><cr_lf>Not Set!<cr_lf>	<cr_lf>92,00,Not Set!<cr_lf>
ATSI,18	<cr_lf>OK<cr_lf><cr_lf>04<cr_lf>	<cr_lf>93,00,04<cr_lf>
ATSI,19	<cr_lf>OK<cr_lf><cr_lf>00,<cr_lf>01,<cr_lf>02, <cr_lf>03,<cr_lf>	<cr_lf>94,00<cr_lf>00,<cr_lf>01,<cr_lf>02,<cr_lf> <cr_lf>03,<cr_lf>
ATSI,20	<cr_lf>OK<cr_lf><cr_lf>1101<cr_lf>	<cr_lf>110,00,1101<cr_lf>
ATSI,21	<cr_lf>OK<cr_lf><cr_lf>00,01<cr_lf>	<cr_lf>127,00,00,00<cr_lf>
ATSI,22	<cr_lf>OK<cr_lf><cr_lf>1<cr_lf>	<cr_lf>131,00,1<cr_lf>
# of Connections		
ATSSW,3	<cr_lf>OK<cr_lf>	<cr_lf>102,00<cr_lf>
	<cr_lf>ERROR<cr_lf>	<cr_lf>102,01<cr_lf>
ATRSW,3	<cr_lf>OK<cr_lf><cr_lf>01<cr_lf>	<cr_lf>103,00,01<cr_lf>
Radio Name		
ATSN	<cr_lf>OK<cr_lf>	<cr_lf>15,00<cr_lf>
	<cr_lf>ERROR<cr_lf>	<cr_lf>15,02<cr_lf>
ATRRN	<cr_lf>OK<cr_lf><cr_lf>BlueRadios<cr_lf>	<cr_lf>109,00,0A,BlueRadios<cr_lf>
	<cr_lf>OK<cr_lf><cr_lf>NO ANSWER<cr_lf>	<cr_lf>109,01<cr_lf>
Service Name		
ATSSN	<cr_lf>OK<cr_lf>	<cr_lf>38,00<cr_lf>
	<cr_lf>ERROR<cr_lf>	<cr_lf>38,03<cr_lf>
ATSSNC	<cr_lf>OK<cr_lf>	<cr_lf>38,00<cr_lf>
	<cr_lf>ERROR<cr_lf>	<cr_lf>38,03<cr_lf>
ATRSN	<cr_lf>OK<cr_lf><cr_lf>COM0<cr_lf>	<cr_lf>18,00,04,COM0<cr_lf>
ATRSNC	<cr_lf>OK<cr_lf><cr_lf>COM0<cr_lf>	<cr_lf>18,00,04,COM0<cr_lf>
ATRRSN	<cr_lf>OK<cr_lf><cr_lf>01,Bluetooth Serial Port<cr_lf>	<cr_lf>108,00,16,Bluetooth Serial Port<cr_lf>
	<cr_lf>OK<cr_lf><cr_lf>NO ANSWER<cr_lf>	<cr_lf>108,01<cr_lf>
Security PIN		

BR-AT_COMMANDS-100 Rev. 3.5.2.1.4.0

SSW,6	<cr_lf>OK<cr_lf>	<cr_lf>102,00<cr_lf>
	<cr_lf>ERROR<cr_lf>	<cr_lf>102,00<cr_lf>
RSW,6	<cr_lf>OK<cr_lf><cr_lf>01<cr_lf>	<cr_lf>103,00,01<cr_lf>
ATSP	<cr_lf>OK<cr_lf>	<cr_lf>39,00<cr_lf>
	<cr_lf>ERROR<cr_lf>	<cr_lf>39,02<cr_lf>
ATOP	<cr_lf>OK<cr_lf>	<cr_lf>78,00<cr_lf>
	<cr_lf>ERROR<cr_lf>	<cr_lf>78,03<cr_lf>
ATPR	<cr_lf>OK<cr_lf>	<cr_lf>132,00<cr_lf>
COD		
ATSC	<cr_lf>OK<cr_lf>	<cr_lf>40,00<cr_lf>
	<cr_lf>ERROR<cr_lf>	<cr_lf>40,02<cr_lf>
Write Memory		
ATSW20	No Response	No Response
ATSW21	<cr_lf>OK<cr_lf>	<cr_lf>47,00<cr_lf>
	<cr_lf>ERROR<cr_lf>	<cr_lf>47,01<cr_lf>
ATSW22	<cr_lf>OK<cr_lf>	<cr_lf>48,00<cr_lf>
	<cr_lf>ERROR<cr_lf>	<cr_lf>48,01<cr_lf>
ATSW23	<cr_lf>OK<cr_lf>	<cr_lf>49,00<cr_lf>
	<cr_lf>ERROR<cr_lf>	<cr_lf>49,01<cr_lf>
ATSW24	<cr_lf>OK<cr_lf>	<cr_lf>34,00<cr_lf>
	<cr_lf>ERROR<cr_lf>	<cr_lf>34,01<cr_lf>
ATSW25	<cr_lf>OK<cr_lf>	<cr_lf>35,00<cr_lf>
	<cr_lf>ERROR<cr_lf>	<cr_lf>35,01<cr_lf>
ATSW26	<cr_lf>OK<cr_lf>	<cr_lf>36,00<cr_lf>
	<cr_lf>ERROR<cr_lf>	<cr_lf>36,01<cr_lf>
ATSW27	<cr_lf>OK<cr_lf>	<cr_lf>46,00<cr_lf>
	<cr_lf>ERROR<cr_lf>	<cr_lf>46,01<cr_lf>
ATSW28	<cr_lf>OK<cr_lf>	<cr_lf>67,00<cr_lf>
	<cr_lf>ERROR<cr_lf>	<cr_lf>67,01<cr_lf>
ATSW29	<cr_lf>OK<cr_lf>	<cr_lf>72,00<cr_lf>
	<cr_lf>ERROR<cr_lf>	<cr_lf>72,01<cr_lf>
ATSW30	<cr_lf>OK<cr_lf>	<cr_lf>74,00<cr_lf>
	<cr_lf>ERROR<cr_lf>	<cr_lf>74,01<cr_lf>
Read Memory		
ATSR21	<cr_lf>OK<cr_lf><cr_lf>0<cr_lf>	<cr_lf>44,00,0<cr_lf>
Inquiry		
ATDI	<cr_lf>OK<cr_lf><cr_lf>123456789012,12345678<cr_lf><cr_lf>DONE<cr_lf>	<cr_lf>12,00<cr_lf><cr_lf>13,123456789012,12345678<cr_lf><cr_lf>51,01<cr_lf>
	<cr_lf>ERROR<cr_lf>	<cr_lf>12,01<cr_lf>
ATIL	<cr_lf>OK<cr_lf><cr_lf>123456789012,12345678<cr_lf><cr_lf>DONE<cr_lf>	<cr_lf>87,00<cr_lf><cr_lf>13,123456789012,12345678<cr_lf><cr_lf>51,01<cr_lf>
	<cr_lf>ERROR<cr_lf>	<cr_lf>87,01<cr_lf>
Master Connect		
ATDM	<cr_lf>OK<cr_lf><cr_lf>CONNECT,123456789012<cr_lf>	<cr_lf>21,00,123456789012<cr_lf>
(w/Security)	<cr_lf>OK<cr_lf><cr_lf>PAIRED,123456789012	<cr_lf>82,123456789012<cr_lf><cr_lf>21,00,1

BR-AT_COMMANDS-100 Rev. 3.5.2.1.4.0

	<cr_lf><cr_lf>CONNECT ,123456789012<cr_lf>	23456789012<cr_lf>
	<cr_lf>ERROR<cr_lf>	<cr_lf>21,02<cr_lf>
	<cr_lf>NO ANSWER<cr_lf>	<cr_lf>21,04<cr_lf>
ATDC	<cr_lf>OK<cr_lf><cr_lf>CONNECT ,123456789012<cr_lf>	<cr_lf>21,00,123456789012<cr_lf>
(w/Security)	<cr_lf>OK<cr_lf><cr_lf>PAIRED,123456789012<cr_lf><cr_lf>CONNECT ,123456789012<cr_lf>	<cr_lf>82,123456789012<cr_lf><cr_lf>21,00,123456789012<cr_lf>
	<cr_lf>ERROR<cr_lf>	<cr_lf>21,02<cr_lf>
	<cr_lf>NO ANSWER<cr_lf>	<cr_lf>21,04<cr_lf>
ATDL	<cr_lf>OK<cr_lf><cr_lf>CONNECT ,123456789012<cr_lf>	<cr_lf>77,00<cr_lf><cr_lf>21,00,123456789012<cr_lf>
(w/Security)	<cr_lf>OK<cr_lf><cr_lf>PAIRED,123456789012<cr_lf><cr_lf>CONNECT ,123456789012<cr_lf>	<cr_lf>77,00<cr_lf><cr_lf>82,123456789012<cr_lf><cr_lf>21,00,123456789012<cr_lf>
	<cr_lf>ERROR<cr_lf>	<cr_lf>77,02<cr_lf>
	<cr_lf>NO ANSWER<cr_lf>	<cr_lf>77,04<cr_lf>
ATLAST	<cr_lf>OK<cr_lf><cr_lf>123456789012<cr_lf>	cr_lf>64,00,123456789012<cr_lf>
Master Default		
AT SMA	<cr_lf>OK<cr_lf>	<cr_lf>42,00<cr_lf>
	<cr_lf>ERROR<cr_lf>	<cr_lf>42,01<cr_lf>
AT MA CLR	<cr_lf>OK<cr_lf>	<cr_lf>43,00<cr_lf>
	<cr_lf>ERROR<cr_lf>	<cr_lf>43,01<cr_lf>
Connect Slave		
AT DS	<cr_lf>OK<cr_lf>	<cr_lf>22,00<cr_lf>
Disconnect		
AT DH	<cr_lf>OK<cr_lf><cr_lf>DISCONNECT<cr_lf>	<cr_lf>23,00<cr_lf>
	<cr_lf>OK<cr_lf><cr_lf>LINKLOSS<cr_lf>	<cr_lf>23,01<cr_lf>
	<cr_lf>ERROR<cr_lf>	<cr_lf>23,02<cr_lf>
AT DH C	<cr_lf>OK<cr_lf><cr_lf>DISCONNECT,00<cr_lf>>	<cr_lf>23,00,00<cr_lf>
	<cr_lf>OK<cr_lf><cr_lf>LINKLOSS,00<cr_lf>	<cr_lf>23,01,00<cr_lf>
	<cr_lf>ERROR<cr_lf>	<cr_lf>23,03<cr_lf>
Modes		
+++	<cr_lf>OK<cr_lf>	<cr_lf>32,00<cr_lf>
AT S E S C	<cr_lf>OK<cr_lf>	<cr_lf>65,00<cr_lf>
	<cr_lf>ERROR<cr_lf>	<cr_lf>65,01<cr_lf>
AT M D	<cr_lf>OK<cr_lf>	<cr_lf>31,00<cr_lf>
	<cr_lf>NO CARRIER<cr_lf>	<cr_lf>31,03<cr_lf>
AT M F	<cr_lf>OK<cr_lf>	<cr_lf>33,00<cr_lf>
	<cr_lf>ERROR<cr_lf>	<cr_lf>33,01<cr_lf>
	<cr_lf>NO CARRIER<cr_lf>	<cr_lf>33,02<cr_lf>
Cancel		
AT U C L	<cr_lf>OK<cr_lf>	<cr_lf>51,00<cr_lf>
Pairing		
AT PA I R	<cr_lf>OK<cr_lf><cr_lf>PAIRED,123456789012<cr_lf>	<cr_lf>70,00<cr_lf><cr_lf>82,123456789012<cr_lf>

BR-AT_COMMANDS-100 Rev. 3.5.2.1.4.0

	<cr_lf>ERROR<cr_lf>	<cr_lf>70,01<cr_lf>
	<cr_lf>PAIRED,FAILED<cr_lf>	<cr_lf>70,02<cr_lf>
ATUPAIR	<cr_lf>OK<cr_lf>	<cr_lf>80,00<cr_lf>
	<cr_lf>ERROR<cr_lf>	<cr_lf>80,02<cr_lf>
ATUPAIRB	<cr_lf>OK<cr_lf>	<cr_lf>96,00<cr_lf>
	<cr_lf>ERROR<cr_lf>	<cr_lf>96,02<cr_lf>
ATCPAIR	<cr_lf>OK<cr_lf>	<cr_lf>97,00<cr_lf>
Sniff and Park		
ATSNIFF	<cr_lf>OK<cr_lf>	<cr_lf>27,00<cr_lf>
	<cr_lf>NO CARRIER<cr_lf>	<cr_lf>27,02<cr_lf>
ATSSNIFF	<cr_lf>OK<cr_lf>	<cr_lf>94,00<cr_lf>
	<cr_lf>ERROR<cr_lf>	<cr_lf>94,01<cr_lf>
ATCSNIFF	<cr_lf>OK<cr_lf>	<cr_lf>95,00<cr_lf>
	<cr_lf>ERROR<cr_lf>	<cr_lf>95,01<cr_lf>
ATXSNIFF	<cr_lf>OK<cr_lf>	<cr_lf>28,00<cr_lf>
	<cr_lf>NO CARRIER<cr_lf>	<cr_lf>28,02<cr_lf>
ATPARK	<cr_lf>OK<cr_lf>	<cr_lf>26,00<cr_lf>
	<cr_lf>NO CARRIER<cr_lf>	<cr_lf>26,02<cr_lf>
ATXPARK	<cr_lf>OK<cr_lf>	<cr_lf>29,00<cr_lf>
	<cr_lf>NO CARRIER<cr_lf>	<cr_lf>29,02<cr_lf>
RSSI and Link		
ATRSSI	<cr_lf>OK<cr_lf><cr_lf>-10<cr_lf>	<cr_lf>100,00,+00<cr_lf>
	<cr_lf>ERROR<cr_lf>	<cr_lf>100,02<cr_lf>
ATRSSIC	<cr_lf>OK<cr_lf><cr_lf>-10<cr_lf>	<cr_lf>100,00,+00<cr_lf>
	<cr_lf>ERROR<cr_lf>	<cr_lf>100,02<cr_lf>
ATLQ	<cr_lf>OK<cr_lf><cr_lf>FF<cr_lf>	<cr_lf>101,00,FF<cr_lf>
	<cr_lf>ERROR<cr_lf>	<cr_lf>101,02<cr_lf>
ATLQC	<cr_lf>OK<cr_lf><cr_lf>FF<cr_lf>	<cr_lf>101,00,FF<cr_lf>
	<cr_lf>ERROR<cr_lf>	<cr_lf>101,02<cr_lf>
Audio PCM		
ATDSCO	<cr_lf>OK<cr_lf><cr_lf>SCO CONNECT<cr_lf>	<cr_lf>24,00<cr_lf><cr_lf>24,09<cr_lf>
	<cr_lf>OK<cr_lf><cr_lf>SCO FAILED<cr_lf>	<cr_lf>24,00<cr_lf><<cr_lf>24,10<cr_lf>
	<cr_lf>NO CARRIER<cr_lf>	<cr_lf>24,02<cr_lf>
ATDHSCO	<cr_lf>OK<cr_lf><cr_lf>SCO DISCONNECT<cr_lf>	<cr_lf>25,00<cr_lf><cr_lf>25,11<cr_lf>
	<cr_lf>NO CARRIER<cr_lf>	<cr_lf>25,02<cr_lf>
Max TX Power		
ATSPF	<cr_lf>OK<cr_lf>	<cr_lf>79,00<cr_lf>
	<cr_lf>ERROR<cr_lf>	<cr_lf>79,01<cr_lf>
Link Timeout		
ATLSTO	<cr_lf>OK<cr_lf>	<cr_lf>88,00<cr_lf>
	<cr_lf>ERROR<cr_lf>	<cr_lf>88,01<cr_lf>
Variable Storage		
ATSTORE	<cr_lf>OK<cr_lf>	<cr_lf>90,00<cr_lf>

BR-AT_COMMANDS-100 Rev. 3.5.2.1.4.0

	<cr_lf>ERROR<cr_lf>	<cr_lf>90,01<cr_lf>
ATREAD	<cr_lf>OK<cr_lf>	<cr_lf>91,00<cr_lf>
Variable Storage		
ATSTORE	<cr_lf>OK<cr_lf>	<cr_lf>90,00<cr_lf>
	<cr_lf>ERROR<cr_lf>	<cr_lf>90,01<cr_lf>
ATREAD	<cr_lf>OK<cr_lf>	<cr_lf>91,00<cr_lf>
Variable Storage		
ATSTORE	<cr_lf>OK<cr_lf>	<cr_lf>90,00<cr_lf>
	<cr_lf>ERROR<cr_lf>	<cr_lf>90,01<cr_lf>
ATREAD	<cr_lf>OK<cr_lf>	<cr_lf>91,00<cr_lf>
Conn PIO Logic		
ATSSW,4	<cr_lf>OK<cr_lf>	<cr_lf>102,00<cr_lf>
	<cr_lf>ERROR<cr_lf>	<cr_lf>102,01<cr_lf>
ATRSW,4	<cr_lf>OK<cr_lf><cr_lf>00<cr_lf>	<cr_lf>103,00,00<cr_lf>
Transmission Ch		
ATSWC	<cr_lf>OK<cr_lf>	<cr_lf>121,00<cr_lf>
	<cr_lf>ERROR<cr_lf>	<cr_lf>121,03<cr_lf>
Discoverability		
ATSDIS	<cr_lf>OK<cr_lf>	<cr_lf>114,00<cr_lf>
ATUDIS	<cr_lf>OK<cr_lf>	<cr_lf>115,00<cr_lf>
FTP Con/Discon		
ATDFTP	<cr_lf>OK<cr_lf><cr_lf>FTP CONNECT,123456 789012<cr_lf>	<cr_lf>111,00,123456789012<cr_lf>
	<cr_lf>ERROR<cr_lf>	<cr_lf>111,01<cr_lf>
	<cr_lf>FTP NO ANSWER<cr_lf>	<cr_lf>111,03<cr_lf>
ATDHFTP	<cr_lf>OK<cr_lf><cr_lf>FTP DISCONNECT<cr_lf>	<cr_lf>112,00<cr_lf>
	<cr_lf>ERROR<cr_lf>	<cr_lf>112,01<cr_lf>
FTP Directory		
ATFTPB	<cr_lf>OK<cr_lf><XML Directory Information> <cr_lf>BROWSE COMPLETE<cr_lf>	<cr_lf>112,00<cr_lf><XML Directory Information><cr_lf>113,01<cr_lf>
	<cr_lf>ERROR<cr_lf>	<cr_lf>113,02<cr_lf>
ATFTPSUB	<cr_lf>OK<cr_lf>	<cr_lf>116,00<cr_lf>
	<cr_lf>ERROR<cr_lf>	<cr_lf>116,01<cr_lf>
	<cr_lf>ERROR<cr_lf>	<cr_lf>116,02<cr_lf>
ATFTPUP	<cr_lf>OK<cr_lf>	<cr_lf>118,00<cr_lf>
	<cr_lf>ERROR<cr_lf>	<cr_lf>118,01<cr_lf>
ATFTPROOT	<cr_lf>OK<cr_lf>	<cr_lf>117,00<cr_lf>
	<cr_lf>ERROR<cr_lf>	<cr_lf>117,01<cr_lf>
FTP Push/Pull		
ATFTPPUSH	<cr_lf>OK<cr_lf><cr_lf>SENT,0001<cr_lf><cr_lf> >SENT,0051<cr_lf><cr_lf>PUSH COMPLETE<cr_lf>	<cr_lf>120,00<cr_lf><cr_lf>120,01,0001<cr_lf> ><cr_lf>120,01,0051<cr_lf><cr_lf>120,02<cr_lf> <cr_lf>

BR-AT_COMMANDS-100 Rev. 3.5.2.1.4.0

	<cr_lf>ERROR<cr_lf>	<cr_lf>120,03<cr_lf>
	<cr_lf>ERROR<cr_lf>	<cr_lf>120,04<cr_lf>
	<cr_lf>ERROR<cr_lf>	<cr_lf>120,05<cr_lf>
ATFTPPULL	<cr_lf>OK<cr_lf><cr_lf>File,0030,<30 Bytes of Data><cr_lf><cr_lf>PULL COMPLETE<cr_lf>	<cr_lf>119,00,001E,<30 Bytes of Data><cr_lf><cr_lf>119,01<cr_lf>
	<cr_lf>ERROR<cr_lf>	<cr_lf>119,03<cr_lf>
	<cr_lf>ERROR<cr_lf>	<cr_lf>119,04<cr_lf>
FTP Server		
File Push	<cr_lf>FTP CONNECT,0123456789012<cr_lf><cr_lf>PUSH START,<File Name>,<Size><cr_lf><Data><cr_lf><cr_lf>PUSH COMPLETE <cr_lf><cr_lf>FTP<cr_lf>	<cr_lf>111,00,123456789012<cr_lf><cr_lf>129,01,<File Name>,<Size><cr_lf><Data><cr_lf><cr_lf>129,02<cr_lf><cr_lf>112,00<cr_lf>
OPP Con/Discon		
ATDOPP	<cr_lf>OK<cr_lf><cr_lf>OPP CONNECT,123456789012<cr_lf>	<cr_lf>122,00,123456789012<cr_lf>
	<cr_lf>ERROR<cr_lf>	<cr_lf>122,01<cr_lf>
	<cr_lf> OPP NO ANSWER<cr_lf>	<cr_lf>122,03<cr_lf>
ATDHOPP	<cr_lf>OK<cr_lf><cr_lf> OPP DISCONNECT<cr_lf>	<cr_lf>123,00<cr_lf>
	<cr_lf>ERROR<cr_lf>	<cr_lf>123,01<cr_lf>
OPP Push/Pull		
ATSBCARD	<cr_lf>OK<cr_lf><vCard Data><cr_lf>PUSH COMPLETE<cr_lf>	<cr_lf>125,00<cr_lf><vCard Data><cr_lf>125,02<cr_lf>
	<cr_lf>ERROR<cr_lf>	<cr_lf>125,03<cr_lf>
	<cr_lf>ERROR<cr_lf>	<cr_lf>125,04<cr_lf>
	<cr_lf>ERROR<cr_lf>	<cr_lf>125,05<cr_lf>
ATRBCARD	<cr_lf>OK<cr_lf><cr_lf><vCard Data><cr_lf><cr_lf>PULL COMPLETE<cr_lf>	<cr_lf>126,00,<vCard Data><cr_lf><cr_lf>126,01<cr_lf>
	<cr_lf>ERROR<cr_lf>	<cr_lf>126,02<cr_lf>
	<cr_lf>ERROR<cr_lf>	<cr_lf>126,03<cr_lf>
ATOPPPUSH	<cr_lf>OK<cr_lf><cr_lf>PUSH COMPLETE<cr_lf>	<cr_lf>124,00<cr_lf><cr_lf>124,02<cr_lf>
	<cr_lf>ERROR<cr_lf>	<cr_lf>124,03<cr_lf>
	<cr_lf>ERROR<cr_lf>	<cr_lf>124,04<cr_lf>
OPP Server		
ATBCARDR	<cr_lf>OK<cr_lf><vCard Data><cr_lf>PULL COMPLETE<cr_lf>	<cr_lf>128,00<cr_lf><vCard Data><cr_lf>128,05<cr_lf>
	<cr_lf>ERROR<cr_lf>	<cr_lf>128,03<cr_lf>
Business Card Push	<cr_lf>OPP CONNECT,123456789012<cr_lf><cr_lf>PUSH START,<File Name>,<Size><cr_lf><cr_lf><Data><cr_lf><cr_lf>PUSHCOMPLETE<cr_lf><cr_lf>OPP DISCONNECT<cr_lf>	<cr_lf>122,00,123456789012<cr_lf><cr_lf>124,01,<File Name>,<Size><cr_lf>data<cr_lf>124,02<cr_lf><cr_lf>123,00<cr_lf>

Appendix C: UUID Table

The Highlighted Universal Unique Identifiers (UUID's) have been tested as both Client and Server. Others may be activated, but the results are unknown.

Profile Name	UUID
Serial Port Profile (SPP)	1101
LAN Accessing PPP	1102
Dial-up Network (DUN)	1103
IrMC Sync	1104
OPP - Object Push/Pull	1105
OBEX File Transfer (Client) only	1106
IrMC Sync Command	1107
Headset	1108
Cordless Telephone (CTP)	1109
Intercom	1110
Fax	1111
Audio Gateway	1112
WAP	1113
WAP_CLIENT	1114
BNEP/PAN (Client)	0000